

IT8200

Regenerative AC/DC Electronic Load



Your Power Testing Solution

Cal Power

Via Acquanera, 29 22100 COMO
tel. 031.526.566 (r.a.) fax 031.507.984
info@calpower.it www.calspower.it

IT8200

Regenerative AC/DC Electronic Load



Adopting advanced SiC technology, IT8200 Series is a regenerative programmable AC/DC electronic load. It is power regenerative, which not only saves electricity and cooling costs for you, but also good for energy saving and environmental protection. AC load mode supports both rectification and non-rectification, providing CC/CR/CP/CS/CC+CR/CE operating modes. It can simulate multiple circuit topologies under CE mode such as single-phase rectification RLC Circuit and parallel RLC Circuit. IT8200 can be applied to the test of V2G, EVSE, PCS, UPS, inverter, etc.

IT8200 Series adopt a high power density design, and the power can reach 15kVA in a 3U unit. After parallel connection, the power can be extended to 960kVA at most. Its LCD touch screen with graphical UI interface can directly define different waveforms. Combined with arbitrary waveform editing function and perfect protection function, it is an ideal choice for R&D testing and system construction.

FEATURE

- Adopt advanced SiC technology
- High power density, 15kVA in 3U unit, 6kVA in 1U/2U
- Measure up to 16 parameters including Vrms/Arms/Freq/CF/PF/UTHD/ITHD/±Vpeak.
- Master/Slave parallel, power up to 960kVA
- High efficient energy regeneration
- Voltage - 350 VL-N
- Comprehensive working modes selectable: single-phase, three-phase, reverse phase (split phase). Rated voltage can be extended to 200% under reverse phase (split phase)
- Frequency: 16-500Hz
- Support NORMAL/LIST/SWEEP/Surge&Sag modes
- Built-in various waveforms
- Touch screen, simple UI for easy operation
- Built-in USB/CAN/LAN/Digital IO interface, optional GPIB/Analog&RS232
- DC mode supports nine working modes, including CC, CR, CP, and CV
- Support CANopen*3、Modbus、LXI、SCPI communication
- AC mode supports CC/CP/CR/CS/CC+CR/CE multiple working modes, CE mode can simulate 14 circuit topologies such as single-phase rectifier RLC and parallel RLC
- AC mode supports both rectification and non-rectification modes
- DC mode supports 9 working modes such as CC/CR/CP/CV
- Adjustable crest factor: 1.414 ~ 5.0
- Supports phase shift, ranging from -90° to 90.0° *1
- The unit power factor1 function allows the current waveform to vary with the voltage waveform and the power factor is as close to 1 as possible
- In three-phase AC mode, two access modes are supported: Y and Δ
- Comprehensive harmonics measurement and analysis, up to 50th. Built-in IEC61000-3-2/3-12 pre-compliance test standard *2
- Support the loading and unloading angle control, the full range of $0-359^{\circ}$ can be set
- Various protection functions such as Protect auto clear (UV&FE auto Clear), POVP, POCP, UVP, Software watchdog

*1 After the rectification function is enabled, the setting range of phase shift is restricted by the peak factor

*2 Voltage/current harmonic analysis, current harmonic simulation, fundamental wave ≤ 60 Hz

*3 coming soon

Your Power Testing Solution

IT8200 Regenerative AC/DC Electronic Load

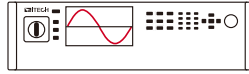

APPLICATION



Solar

Grid-connected inverter,
Hybrid inverter



Energy storage

PCS,
Micro-grid



EV

V2G, EVSE,
converters



Power electronics

UPS, AC power supply,
frequency converter,
generator

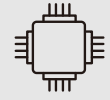

Electronic components

Circuit breaker,
fuse, connectors,
switches

Model	Rated Vac		Rated Amps/Phs		Rated Pac	Phase	Height	Display
	V L-N	V L-L	Arms(1Φ)	Arms(3Φ)				
IT8202-350-10U-ATE	350V	—	10A	—	2kVA	1Φ	1U	—
IT8202-350-10U	350V	—	10A	—	2kVA	1Φ	2U	Touch Screen
IT8203-350-30U	350V	—	30A	—	3kVA	1Φ	3U	Touch Screen
IT8204-350-20U-ATE	350V	—	20A	—	4kVA	1&2Φ	1U	—
IT8204-350-20U	350V	—	20A	—	4kVA	1&2Φ	2U	Touch Screen
IT8205-350-30U	350V	—	30A	—	5kVA	1Φ	3U	Touch Screen
IT8206-350-30-ATE	350V	606V	30A	10A	6kVA	1, 2 & 3 Φ	1U	—
IT8206-350-30	350V	606V	30A	10A	6kVA	1, 2 & 3 Φ	2U	Touch Screen
IT8206-350-90	350V	606V	90A	30A	6kVA	1, 2 & 3 Φ	3U	Touch Screen
IT8209-350-90	350V	606V	90A	30A	9kVA	1, 2 & 3 Φ	3U	Touch Screen
IT8212-350-90	350V	606V	90A	30A	12kVA	1, 2 & 3 Φ	3U	Touch Screen
IT8215-350-90	350V	606V	90A	30A	15kVA	1, 2 & 3 Φ	3U	Touch Screen
IT8230-350-180	350V	606V	180A	60A	30kVA	1, 2 & 3 Φ	6U	Touch Screen
IT8245-350-270	350V	606V	270A	90A	45kVA	1, 2 & 3 Φ	15U	Touch Screen
IT8260-350-360	350V	606V	360A	120A	60kVA	1, 2 & 3 Φ	27U	Touch Screen
IT8275-350-450	350V	606V	450A	150A	75kVA	1, 2 & 3 Φ	27U	Touch Screen
IT8290-350-540	350V	606V	540A	180A	90kVA	1, 2 & 3 Φ	27U	Touch Screen
IT82105-350-630	350V	606V	630A	210A	105kVA	1, 2 & 3 Φ	27U	Touch Screen
IT82120-350-720	350V	606V	720A	240A	120kVA	1, 2 & 3 Φ	37U	Touch Screen
IT82135-350-810	350V	606V	810A	270A	135kVA	1, 2 & 3 Φ	37U	Touch Screen
IT82150-350-900	350V	606V	900A	300A	150kVA	1, 2 & 3 Φ	37U	Touch Screen
IT82165-350-990	350V	606V	990A	330A	165kVA	1, 2 & 3 Φ	37U	Touch Screen

* Please contact ITECH for high power needs.

* The above specifications are subject to update without notice.

Your Power Testing Solution

IT8200 Regenerative AC/DC Electronic Load

Regenerative AC/DC electronic load

The IT8200 series are new regenerative AC Electronic Load with 88% energy recovery capability. Whether in AC mode or DC mode, the power generated by the DUT can be fed back to the grid, rather than being dissipated as heat, which protects the environment and save the cost of electricity, HVAC and cooling infrastructure.

Production facility

24hours/day x 7 working days x 52 weeks



Power (kW)	Electricity saved (appr.USD/year)	CO2 emission reduced (appr.ton/year)
15	17,428	124
90	104,570	745
165	191,712	1,365
960	1,115,412	7,943

R&D lab

8hours/day x 5 working days x 52 weeks



Power (kW)	Electricity saved (appr.USD/year)	CO2 emission reduced (appr.ton/year)
15	4,368	30
90	26,208	177
165	48,048	325
960	279,552	1,891

* The data is based on :

1. approximate electricity price 0.14USD/kWh for industry facility

2. 1kWh power consumption ≈ 0.997 CO2 emission

* The extra cost of air conditioning is not included.

High power density

From 1U/2U/3U single unit to 27U/37U cabinet, various models of IT8200 series can meet the testing needs from 2k to 165kVA. Its voltage can reach 350V. The size of a 3U/15 kVA is only 1/12 of the traditional AC load, which greatly saves the testing space and brings you a high-power testing instrument that can be placed directly on the bench.

*Optional rack-mounting kit IT-E155A is required for 1U models

Master/slave parallel, large capacity free combination

The 3U model of IT8200 can be master-slave paralleled to reach 960kVA output at most. It can improve the output current and power capacity to meet the requirements of higher power testing. IT8200 comes with synchronous On/Off input and output signals, which ensure the synchronization of paralleling and ensures synchronous current sharing of multiple modules. After paralleling, all functions are retained and there' s no loss of accuracy, making the construction of the power system faster, more flexible, and more economical, either it is a stand-alone test or ATE system.

*350V 3U models with the same power can be connected in parallel, 350V 1U/2U models with the same power can be connected in parallel

1U 2U 3U



Your Power Testing Solution

IT8200 Regenerative AC/DC Electronic Load

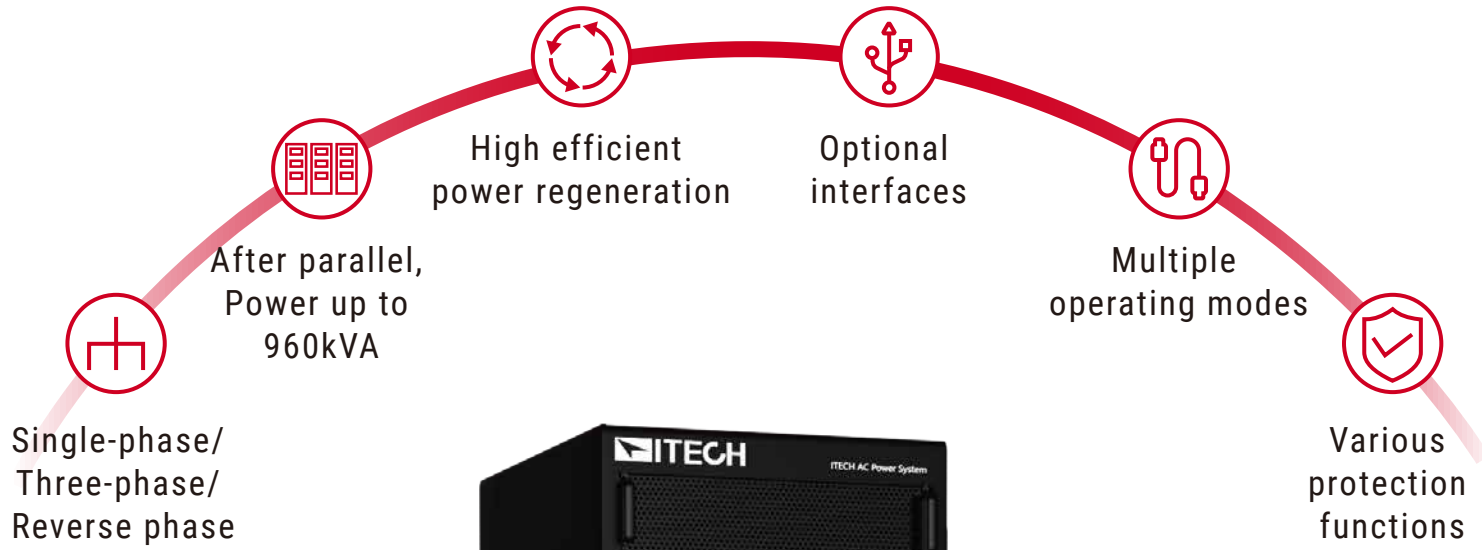

IT8200



15U | 27U | 37U

Your Power Testing Solution

IT8200 Regenerative AC/DC Electronic Load

Single-phase, three-phase, reverse-phase

The IT8200 series has single-phase, three-phase, and reverse-phase output modes, which can be selected through the menu. Under reverse mode, the single-phase 350V input voltage can be increased to 700V with the power down to 2/3 of the original. Under the three-phase mode, you can choose a Y-type or a Δ -type connection. The Y-type connection supports the C-phase loss.

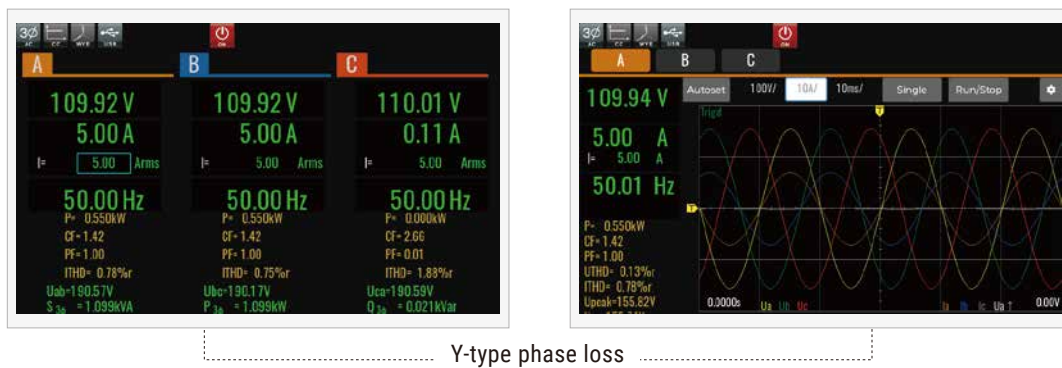
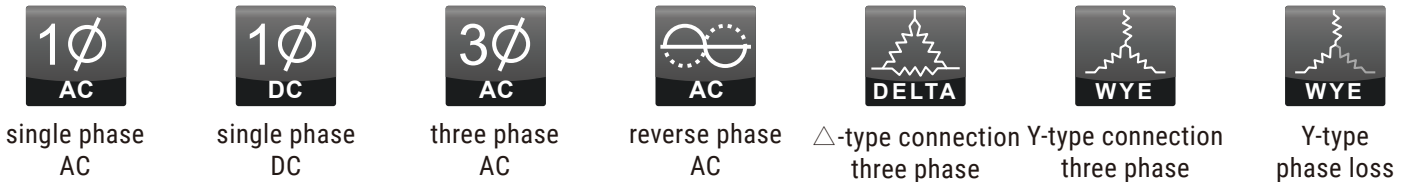

CF 1.414-5.0

The crest factor indicates the extreme peaks of the waveform. For applications that require a pure sine wave, it is desirable to have a CF value of the load current waveform of 1.414 or as close as possible. However, in practical applications, the peak shape of the current waveform of the load may become very sharp and its CF is often higher than 1.414. At this time, the starting point of the sine wave starts to shift from 0 degrees to the positive degree. So you need to correct the waveform. The Crest Factor of the IT8200 can be adjusted from 1.414 to 5.0, and it also allows to set the phase shift angle from $-90^\circ \sim 90^\circ$, correct the resulting amplitude, and keep the RMS unchanged. This enables more accurate simulation of field test conditions to ensure the reliability of the unit under test (UUT).

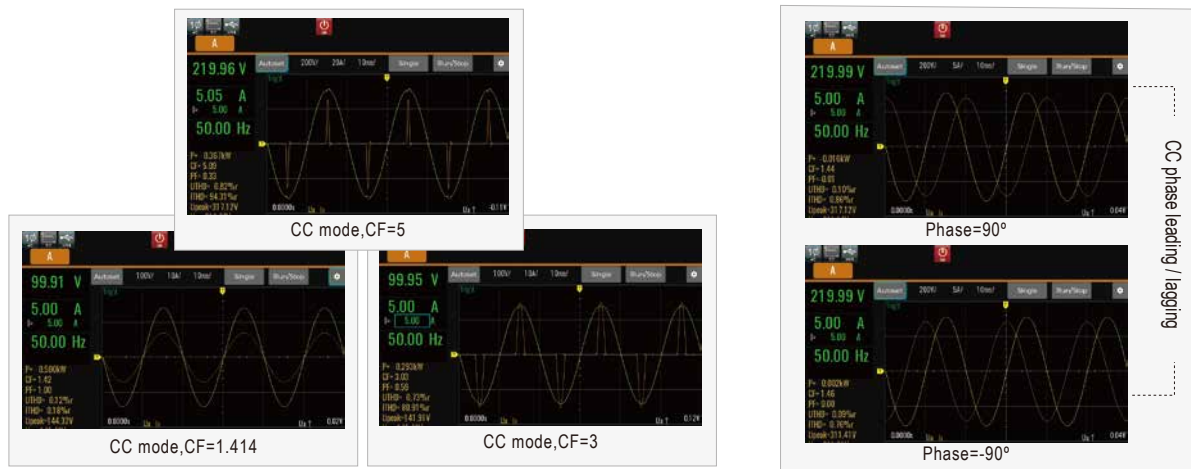









Your Power Testing Solution

IT8200 Regenerative AC/DC Electronic Load







IT8200 Regenerative AC/DC Electronic Load

AC/DC load conditions emulation

DC load mode

-  Constant Voltage (CV)
-  Constant Current (CC)
-  Constant Resistance (CR)
-  Constant Power (CP)
-  CC+CV
-  CR+CV
-  CP+CV
-  CC+CR
-  CP+CV+CR+CC

AC load mode

-  Constant Current (CC)
-  Constant Resistance (CR)
-  Constant Power (CP)
-  Constant apparent power (CS)
-  CC+CR
-  CE RLC

14
circuit
topologies

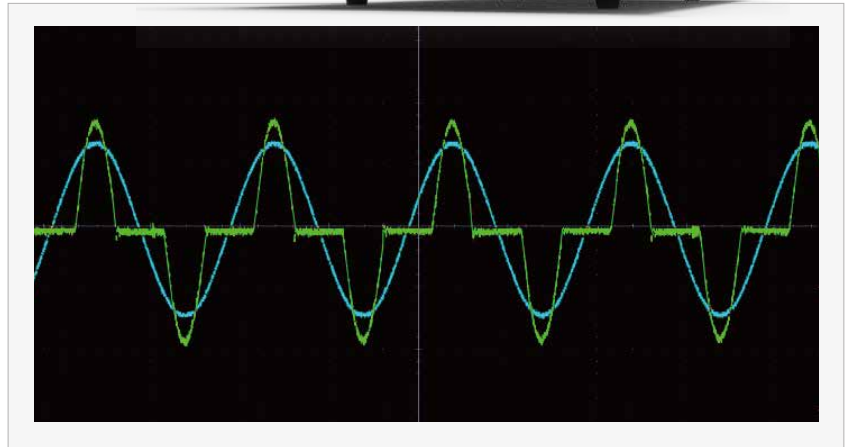
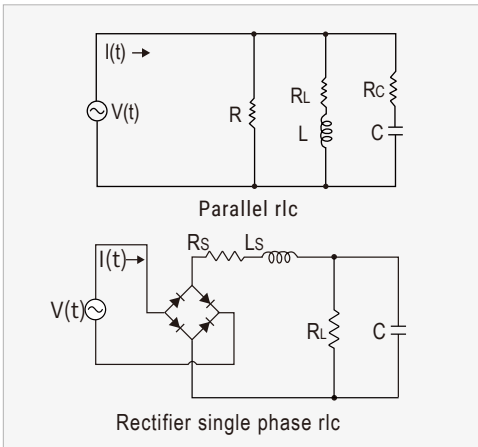

IT8200 AC electronic load can enable the 'Rectified' function in AC mode, so that the load works in the first and third quadrants to ensure that the voltage and current flow always in the same direction. At this time, full wave, positive half wave, or negative half wave can be freely selected.

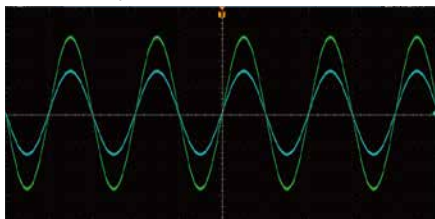

full wave

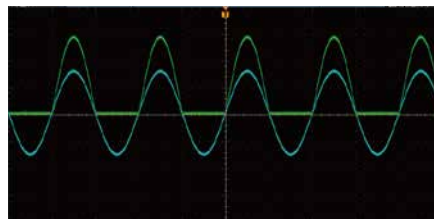

positive half wave

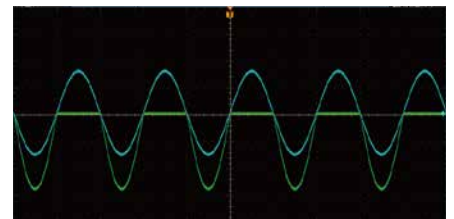

negative half wave

Your Power Testing Solution

IT8200 Regenerative AC/DC Electronic Load

Waveform

Oscilloscope function

The IT8200 series has built-in digital oscilloscope functions, which can collect time domain signals of voltage and current, phase relationship, and perform waveform triggering, etc. Its sampling rate is as high as 10us, up to 6 oscilloscope curves can be displayed at the same time, and instantaneous analysis can be completed.

Further more, with its data recording function, you can observe the output for a long time, and store the obtained data to an external storage device for secondary analysis. A wide variety of test requirement can be met even without a data acquisition instrument or an oscilloscope.



Data record

Thanks to the data record function, the IT8200 series can continuously record data for up to 7 hours at the fastest time interval of 100ms, and provides you with a 'trend' graph to check the curve of the entire test process. Up to 6 curves can be displayed simultaneously. In addition, you can also observe the precise data at a certain moment in the trend graph by sliding on the front panel. This function helps to analyze the abnormality of DUT during long-term testing, inflection point under loading, etc. Test data can be exported by a USB for further analysis.



Harmonic analysis

Harmonic analysis functions include both voltage and current harmonic measurement. In the harmonic mode, the voltage and current total harmonic distortion (THD) and the phase difference test of the harmonic to the fundamental wave can be realized. In addition, you can make multiple harmonic measurements. The test results are displayed in a list, histogram or vector diagram, easy to check. In the meantime, IT8200 AC electronic load also has built-in IEC 61000-3-2 / 61000-3-12 regulations, which can be recalled directly for pre-compliance testing.



Your Power Testing Solution

IT8200 Regenerative AC/DC Electronic Load

Built-in multiple waveforms

IT8200 has built-in sine, triangle, square, trapezoidal and clipped-sine wave. These waveforms can be recalled through the menu and displayed on the screen. Further more, the complex testing requirement can be met by further editing the relevant parameters.



Harmonic simulation

Harmonic test is one of the important test items for EMC immunity. IT8200 series has built-in 30 THD waveforms for quick recall. Thanks to the high-speed DSP technology, IT8200 series can also customize THD waveform. By setting the amplitude and phase, it can simulate up to 50th order harmonics (fundamental frequency is 50Hz or 60Hz), forming a periodic distortion waveform.



Intuitive software interface

IT8200 series provides free PC software PV8200 with an intuitive GUI. Meanwhile, it allows remote control, even the ATE models without display screen can be programmed, communicated and monitored.



Your Power Testing Solution

IT8200 Regenerative AC/DC Electronic Load

LIST/SWEEP/Surge&Sag

IT8200 series supports NORMAL, LIST and SWEEP mode. Each mode can work with Surge&Sag function.

In LIST mode, you can edit multiple steps and any waveform can be selected for each step. One List file can contain maximum 200 steps. Parameters such as frequency, amplitude, running time, and rising slope of each waveform can be edited.

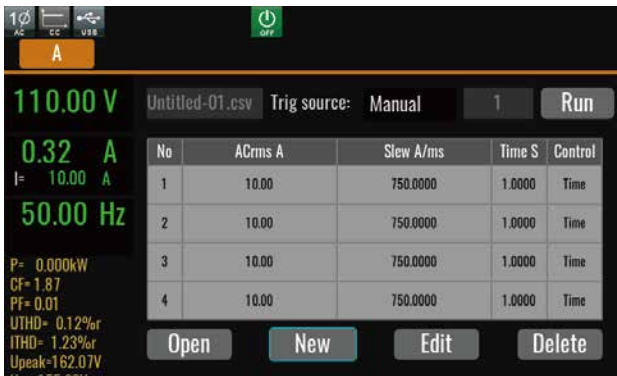

The SWEEP function helps to test the efficiency of the switching power supply in AC mode, grab the voltage and frequency of the maximum power point, and make the setting parameters change step by step.

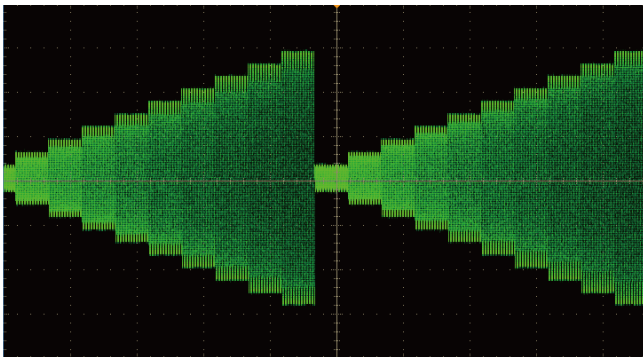

Surge&Sag works in each mode of NORMAL/LIST/SWEEP. Use trigger or cycle to control the drop of surge and sag, set the starting angle of the drop, and support waveform smoothing, symmetrical and asymmetrical waveform operations. Waveforms can be quickly created to reproduce waveform distortions or transient events such as spikes, dropouts or any other anomalies.

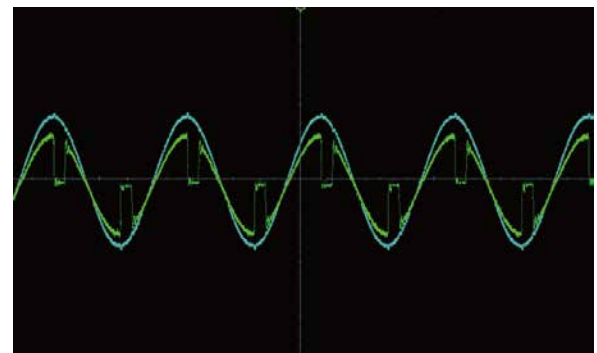

Your Power Testing Solution

IT8200 Regenerative AC/DC Electronic Load

IT8215-350-90				
AC parameter				
AC Input	Wiring connection	3phase 3wire + ground(PE)		
	Line voltage	RMS	(200 ~ 220 V) ±10% *1 (380 ~ 480V) ±10%	
	Line current	RMS	< 34A	
	Apparent power	< 17kVA		
	Frequency	45 ~ 65Hz		
	Power factor	typ	0.98	
Input				
AC mode	Input voltage	VLN	30 ~ 350V	
		VLL	51.96 ~ 606V(3phase)/30 ~ 700V(reverse)	
	Input frequency	16 ~ 500Hz		
	Input current	RMS	90A(1phase)/30A(3phase/reverse)	
		Peak	270A(1phase)/90A(3phase/reverse)	
		Crest Factor *2	5	
	Input power	Per Phase	5kVA	
		Max. Power	10kVA(reverse phase)/15kVA(1phase/3phase)	
	CC mode setting			
	Current range	RMS	90A(1phase)/30A(3phase/reverse)	
Resolution	0.01A			
Accuracy*3	<0.1% + 0.2% F.S.(DC,16Hz ~ 150Hz)/<0.2% + 0.3% F.S.(150.1Hz ~ 500Hz *4)			
CP mode setting				
Range	Max. Power	15kW(1phase/3phase)/10kW(reverse phase)		
	Per Phase	5kW(3phase)		
Resolution	0.001kW			
Accuracy	<0.4% +0.4% F.S.(DC,16Hz ~ 500Hz)			
CS mode setting				
Range	Max. Power	15kVA(1phase/3phase)/10kVA(reverse phase)		
	Per Phase	5kVA(3phase)		
Resolution	0.001kVA			
Accuracy	<0.4% +0.4% F.S.(DC,16Hz ~ 500Hz)			
CR mode setting				
Range	0.334 ~ 388.88Ω(1phase) / 1.002 ~ 1166.6Ω (3phase/reverse phase)			
Resolution	0.001Ω			
Accuracy*5	0.4%+0.4%F.S.			
Circuit Emulation(CE)-Parallel rlc				
R Range	0.334 ~ 388.88Ω(1phase) / 1.002 ~ 1166.6Ω(3phase/reverse phase)			
L Range	1 ~ 2000mH(1phase)/3 ~ 2000mH(reverse phase)/3 ~ 2000mH(3phase)			
C Range	0.001 ~ 9900uF(1phase)/0.001 ~ 3300uF(reverse phase)/0.001 ~ 3300uF(3phase)			
Rc Range	0.334 ~ 388.88Ω(1phase) / 1.002 ~ 1166.6Ω(3phase/reverse phase)			
RL Range	0.334 ~ 388.88Ω(1phase) / 1.002 ~ 1166.6Ω(3phase/reverse phase)			
IL Range	0 ~ 272.7A(1phase)/0 ~ 90.90A(reverse phase)/0 ~ 90.90A(3phase)			
Max peak current	272.7A(1phase)/90.9A(reverse phase)/90.9A(3phase)			
Circuit Emulation(CE)-Rectifier single phase rlc				
R Range	0.334 ~ 388.88Ω(1phase) / 1.002 ~ 1166.6Ω(3phase/reverse phase)			
L Range	0.1 ~ 2000mH(1phase)/0.3 ~ 2000mH(reverse phase)/0.3 ~ 2000mH(3phase)			
C Range	0.001 ~ 9900uF(1phase)/0.001 ~ 3300uF(reverse phase)/0.001 ~ 3300uF(3phase)			
RS Range	0 ~ 388.88Ω(1phase) / 0 ~ 1166.6Ω(3phase/reverse phase)			
Vcap Range	0 ~ 499.924V(1phase)/0 ~ 499.924V(reverse phase)/0 ~ 499.924V(3phase)			
Vdiode RangeL	0 ~ 5V(1phase)/0 ~ 5V(reverse phase)/0 ~ 5V(3phase)			
Max peak current	272.7A(1phase)/90.9A(reverse phase)/90.9A(3phase)			

* 1 (200~220) ±10%, models of 12Kw and above output 60% of rated power.

* 2 Under the input frequency of 50Hz/60Hz, the maximum CF is 5 without exceeding the peak current; under the condition of full current and full power, the maximum CF is 3.

* 3 For frequency <150Hz, the minimum current for accuracy test is 1%F.S., for frequency>150Hz, the minimum current for accuracy test is 3%F.S.

* 4 When LoopSpeed is Low, it is more adaptable to the load; when LoopSpeed is Fast, the dynamic response is faster; when the frequency is high, use Fast mode.

* 5 Under condition: I >10%F.S., F<150Hz.

* The above specifications are subject to update without notice.

		Phase angle setting
AC mode	Range	-82.8°~+82.8°(Rectified Mode *6) -90°~+90°
	Resolution	0.01°
	Accuracy*7	1% F.S.
		CF setting
DC mode	Range	1.414 ~ 5.0
	Resolution	0.001
	Voltage	30 ~ 499V
	Current	30 ~ 499V(1phase)/30 ~ 998V(reverse phase)
	Current rising time	0 ~ 90A(1phase)/0 ~ 30A(reverse phase)
		Measure Parameter
Voltage RMS	Range	0 ~ 350Vrms
	Resolution	0.01
	Accuracy	< 0.1%+0.1% F.S.(DC,16Hz ~ 500Hz)
Current RMS	Range	0 ~ 90A
	Resolution	0.01A
	Accuracy	< 0.1% + 0.2% F.S.(DC,16Hz~150Hz)/< 0.2% + 0.3% F.S.(150.1Hz ~ 500Hz)
Peak current	Range	0 ~ 270A
	Resolution	0.1A
	Accuracy	< 0.3% + 0.6% F.S.(16Hz ~ 500Hz)
Input active power	Range	0 ~ 15kW
	Resolution	0.001kW
	Accuracy	< 0.4% +0.4% F.S.
Input reactive power	Range	0 ~ 15kVAR
	Resolution	0.001kVAR
	Accuracy	< 0.4% +0.4% F.S.
Input apparent power	Range	0 ~ 15KVA
	Resolution	0.001KVA
	Accuracy	< 0.4% +0.4% F.S.
CF	Range	1 ~ 5
	Resolution	0.01
PF	Range	0.1 ~ 1
	Resolution	0.01
	Accuracy	1%F.S.
Harmonic	Max.harmonic analysis	up to 50orders(50/60Hz)
		Power regeneration
Regenerative Pmax		15kVA
Output current THD		< 5%
		Other
Efficiency	typ	91%
Protection		OVP, OCP, OPP, OTP, FAN,ECP
Dimension		483.00mm (W)*151.3mm (H)*777.50mm (D) (841.6mm cover and holder included)
Weight		42kg
Working temperature		0 C ~50 C
Programming response time		2ms

* 6 In the rectifier load mode, the setting range of the phase angle is related to CF. The larger the CF, the larger the settable range of the phase angle

* 7 ≤150Hz, 1%F.S., >150Hz, 5%F.S

* 8 Test conditions: input 380VLL/50Hz, output three phases, each phase 350Vrms/50Hz/5kW.

* The above specifications are subject to update without notice

Cal Power

Via Acquanera, 29 22100 COMO
tel. 031.526.566 (r.a.) fax 031.507.984
info@calpower.it www.calspower.it

ITECH ELECTRONICS

www.itechate.com
info@itechate.com



ITECH Web



ITECH Facebook