

MAGNALOAD

DC Electronic Loads: 1.25 kW to 500 kW+

Product Catalog 1.2.0



Innovation in Programmable Power

Magna-Power designs and manufactures robust programmable power products in the USA that set industry standards for quality, size, and control. The company's experience in power electronics is reflected in its 1.25 kW to 2000 kW+ product line, quality service, and reputation for excellence. Today, you will find Magna-Power's standard products at its thousands of customers worldwide, aiding in the manufacture of electric vehicles, simulating solar arrays for development of inverters, steering magnets for particle accelerators, powering radar systems, driving traction controllers for locomotive development, or at a wide range of Universities for cutting-edge energy research.

Quick Facts

Year Founded

1981

Total Power Shipped

350+ megawatts

Headquarters and Manufacturing Location

Flemington, New Jersey USA

Facility Size

73,500 ft²

Vertically Integrated USA Manufacturing

Magna-Power Electronics products are proudly made in the USA at the company's vertically integrated, company designed and owned 73,500 ft² headquarters in Flemington, New Jersey. All engineering, manufacturing and North America product servicing is performed at the company's headquarters.

Magna-Power Electronics utilizes vertical integration in its manufacturing process for complete control over quality, cost, and lead-time of its made-to-order products. As the company has grown, more operations have been internalized.

Vertical integration enables Magna-Power to manufacture a very broad line of sophisticated electronic products, while still maintaining industry leading lead-times. Housing engineering and manufacturing teams in the same facility forces strong collaboration between the two teams for continual process and product improvements.

Internal Company Processes

- Research and development
- Magnetics winding
- Magnetic core punching and cutting
- Full sheet metal operations
- EDM and CNC machining
- Cable harnessing
- Powder coating
- Robotic air- and water-cooled heat-sink fabrication
- Surface-mount and through-hole printed circuit board assembly
- Final assembly, testing, and burn-in

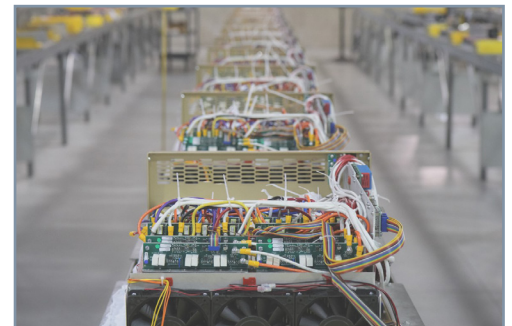
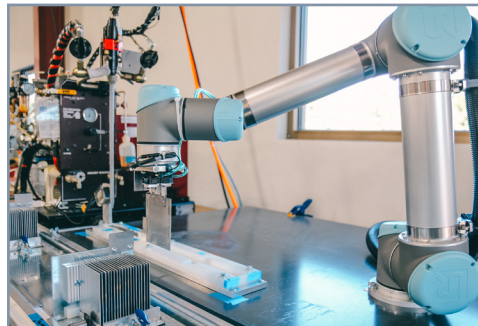
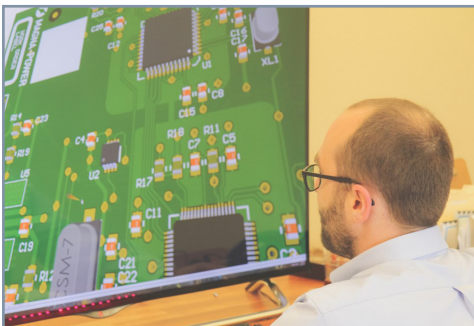



Introduction to MagnaLOADs

An overview of the MagnaLOAD features, functions and front panel

Page 4

ALx Series

Air cooled, linear MOSFET topology, extremely wide operating range

Page 6



Power Levels: 1.25 kW, 2.5 kW, 5 kW, 7.5 kW, 10 kW, 12.5 kW, 15 kW, 17.5 kW, 20 kW

Voltage Range: Models up to 1000 Vdc

Current Range: Models up to 4800 Adc

Number of Models: 27

ARx Series

Air cooled, Active Resistance Technology

Page 12



Power Levels: 6.75 kW, 13.5 kW, 20.25 kW, 27 kW, 33.75 kW, 40.5 kW+

Voltage Range: Models up to 1000 Vdc

Current Range: Models up to 840 Adc

Number of Models: 24

WRx Series

Water cooled, Active Resistance Technology

Page 16



Power Levels: 12.5 kW, 25 kW, 50 kW, 75 kW, 100 kW+

Voltage Range: Models up to 1000 Vdc

Current Range: Models up to 2080 Adc

Number of Models: 20

Electronic Loads – A New Generation

Technical Paper about electronic load topologies and introduction to Magna-Power's Active Resistance topology.

Page 22

MagnaLOAD Overview

MagnaLINK™ Distributed Digital Control

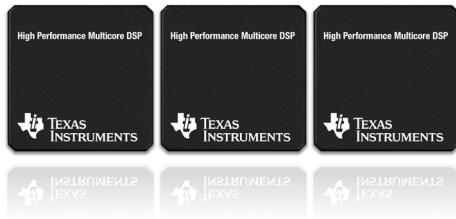

Magna-Power's MagnaLINK™ technology provides distributed Texas Instrument DSP control across power processing stages inside the MagnaLOAD DC electronic load. This technology follows a significant internal development cycle from Magna-Power to provide a unified digital control platform across its electronic loads and power supplies, featuring fully digital control loops, adjustable control gains, programmable slew rates, digital master-slaving, and many new advanced control technologies.

All MagnaLOADs come with the following interfaces:

- Front panel knob, keypad, and menu system
- 25-pin configurable external user I/O, including a high-speed analog input
- Front and rear USB and rear RS-485 or optional Ethernet

When in standby or diagnostic fault, the DC input bus is disconnected via a switching device.

Finally, with a dedicated +5V interlock input pin and included +5V reference on all models, external emergency stop systems can be easily integrated using an external contact.

Flexible Operating Modes

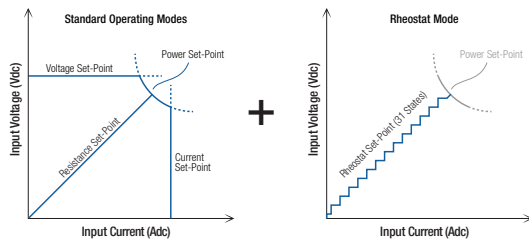

To accommodate a variety of DC sources, all MagnaLOADs come with many configurable control modes, including:

- Voltage Mode
- Current Mode
- Power Mode
- Resistance Mode
- Shunt Regulator Mode
- Rheostat Mode (ARx Series and WRx Series only)

Preference for DC regulation is given to the parameter in the selected mode within the programmed set-points. Using the MagnaLOAD's set-points and trip settings, the product can be configured to either trip with a fault when a limit is exceeded or to cross-over into a different regulation state.

Shunt Regulator Mode turns the MagnaLOAD into a high-speed smart braking resistor, engaging the DC input only when a specified voltage and exceeded by a user-defined percentage, while limiting the shunt current to a programmed set-point.

Configurable External User I/O

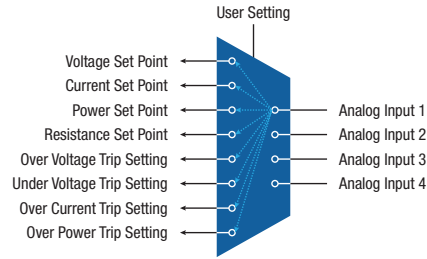

Beyond the front panel and computer controls, all MagnaLOADs come standard with a 25-pin D-Sub connector designated as the External User I/O. This connector provides:

- 8 Digital Outputs
- 4 Digital Inputs
- 4 Analog Outputs
- 4 Analog Inputs

All the analog-digital I/O ports are configurable, allowing the user to select which parameters they want to control and monitor. This configurable I/O scheme reduces complexity, eases PLC integration and allows control parameters from various interfaces simultaneously.

The MagnaLOAD's configurable analog inputs provide 0-10V programming from PLCs and external D/A converters.

Digital Master-Slaving: Expandability Without Compromise

All MagnaLOADs come standard with a MagnaLINK™ Input and a MagnaLINK™ Output port, which provides plug and play digital master-slaving. Simply connect the master's MagnaLINK™ Output to the slave's MagnaLINK™ Input and, using the MagnaWEB software, the products will automatically configure themselves for master-slave operation as a higher-power unit based on the populated ports. Buffered digital MagnaLINK™ connections means many MagnaLOADs can be daisy-chained in master-slave operation. Master-slave MagnaLOAD units will aggregate measurements to one display panel.

The internal MagnaLINK™ protocol was developed with expandability at the forefront. When configured for master-slave operation, the master controller takes control of all the slave's digital "targets." With this digital master-slaving strategy, it is completely transparent whether the unit is operating as a stand-alone product or in master-slave.

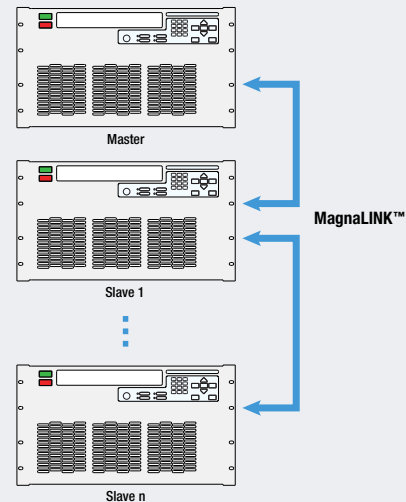

MagnaWEB Software Interface

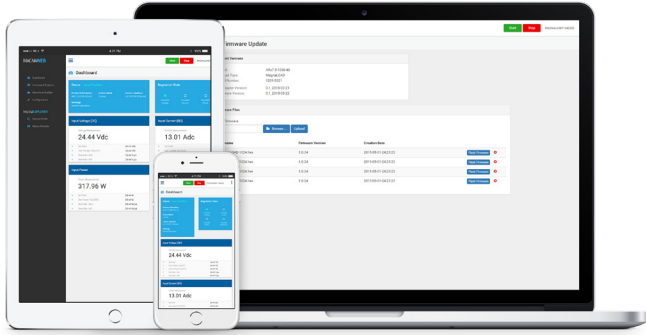

Magna-Power's next generation software interface, MagnaWEB, provides intuitive and user-friendly web-browser based controls for programming and measurement read-back of the MagnaLOAD's activity. Virtually all of the MagnaLOAD's available functions can be controlled and monitored from the MagnaWEB software over any of product's installed communication interfaces.

MagnaWEB uses a server-client software model to provide access to the MagnaLOAD from nearly any device and operating system. Install and run the MagnaWEB software locally on Windows then, using a web browser, access the server connected to the MagnaLOAD from a variety of devices including other desktops, tablets or smart-phones.

Extensive Programming Support

All MagnaLOAD DC electronic loads come with a dedicated National Instruments LabVIEW™ driver, Interchangeable Virtual Instrument (IVI) driver, and support for a wide range of Standard Commands for Programmable Instrumentation (SCPI). These programming interfaces support full control, measurement, and monitoring of the MagnaLOAD. All of the MagnaLOAD's available communication interfaces are supported by these drivers and command sets, including: USB, RS-485, LXI TCP/IP Ethernet, and IEEE-488 GPIB.

Showcased in the following basic code examples, SCPI commands provide the simplest form of communication by using plain ASCII text and parameters sent over a basic socket connection. Over 50 commands are provided, with detailed documentation in the respective product series user manual.

Python programming example using SCPI commands

```
import serial
conn = serial.Serial(port='COM8', baudrate=115200)
conn.write('*IDN?\n')
print conn.readline()
conn.write('VOLT 1000\n')
conn.write('CURR 2.5\n')
conn.write('INP:START\n')
conn.write('MEAS:ALL?\n')
print conn.readline()
```

MagnaLOAD Front Panel - Standard

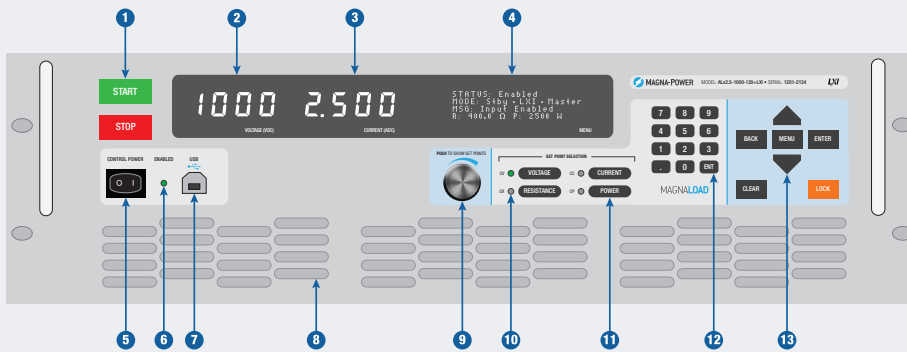

- 1 START: Enables the DC input bus
STOP: Disable the DC input bus
- 2 Voltage measurement display
- 3 Current measurement display
- 4 4-line character display featuring a menu system, operating status and modes, product messages with diagnostic codes, resistance measurement display, and power measurement display
- 5 Control power switch, energizes the control circuits without engaging DC bus
- 6 LED indicator that the DC input is enabled
- 7 Full control (host) front panel USB port
- 8 Clean air intake, with integrated fans
- 9 Aluminium digital encoder knob for programming set-points
- 10 LED indicator of the MagnaLOAD's present regulation state, which can include: constant voltage (CV), constant current (CC), constant power (CP), or constant resistance (CR)
- 11 Illuminated selector buttons to choose which set-point the digital encoder knob and digital keypad buttons will modify.
- 12 MENU: Enters the menu system on the 4-line display
BACK: Moves back one level in the menu
ENTER: Selects the highlighted menu item
CLEAR: Removes the product from a faulted state
LOCK: Locks the front panel

MagnaLOAD Front Panel - Blank Panel (+BP) Option

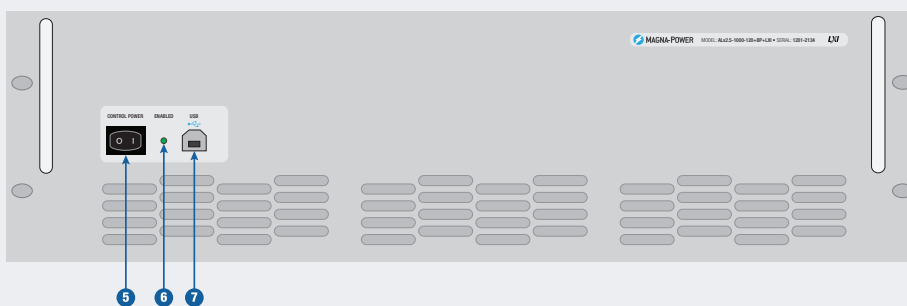

ALx Series

DC Electronic Load • Air cooled, linear MOSFET topology, wide operating range

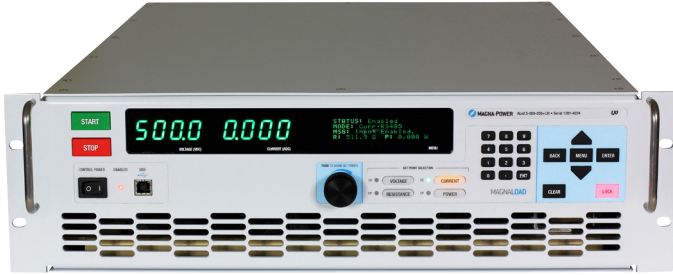

Overview

The ALx Series MagnaLOAD utilizes conventional linear MOSFET-based dissipative elements, allowing the series to achieve a very wide voltage-current operating range within the model's maximum power rating. Using the same heat management innovations developed for Magna-Power's high density programmable DC power supplies, the ALx Series' conservative cooling ensures long product life with continuous full power operation in environments up to 50°C ambient operating temperature.

Technology

The ALx Series uses MOSFETs for power dissipation, delivering among the industry's widest full-power operating for its product class. The ALx Series uses MOSFETs operated in the linear region to allow full power and full control over the entire VA rating of the product.

MOSFETs are specifically selected based on their ability to operate in the linear region and have safe operating curves well below the maximum power rating when used as an electronic switch. Control circuitry for ALx Series MagnaLOADs are operated in a closed loop to linearize the response. Each MOSFET device produces a load current defined by VC/R_n . Closed loop amplifiers enable multiple MOSFETs to share load current equally.

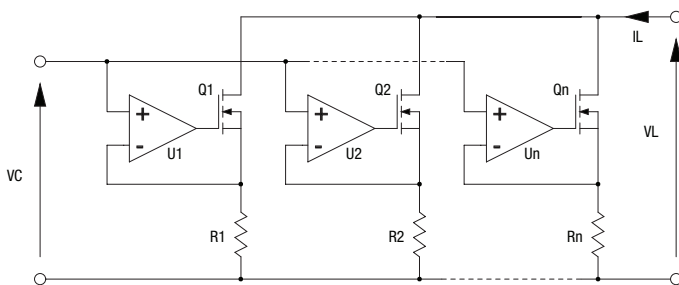

Key Features

- MagnaLINK™ Distributed DSP Architecture
- 16-bit digital programming and monitoring resolution
- SCPI Remote Programming API
- Many control modes, including: voltage, current, power, resistance, and shunt regulator
- Wide voltage-current-power operating profile
- Integrated front and rear full control USB ports, RS485, and dual MagnaLINK™ ports, with LXI TCP/IP Ethernet and IEEE-488 GPIB available.
- Digital plug-and-play master-slaving
- Programmable protection limits
- Configurable external analog-digital user I/O
- Designed and manufactured in the USA

Models

Model	Maximum Power	Maximum Voltage	Maximum Current	Package Type	Minimum Voltage
ALx1.25-200-300	1.25 kW	200 Vdc	300 Adc	Rack-mount	2.5 Vdc
ALx1.25-500-125	1.25 kW	500 Vdc	125 Adc	Rack-mount	6.0 Vdc
ALx1.25-1000-37.5	1.25 kW	1000 Vdc	37.5 Adc	Rack-mount	7.5 Vdc
ALx2.5-200-600	2.5 kW	200 Vdc	600 Adc	Rack-mount	2.5 Vdc
ALx2.5-500-250	2.5 kW	500 Vdc	250 Adc	Rack-mount	6.0 Vdc
ALx2.5-1000-75	2.5 kW	1000 Vdc	75 Adc	Rack-mount	7.5 Vdc
ALx5-200-1200	5 kW	200 Vdc	1200 Adc	Floor-standing	2.5 Vdc
ALx5-500-500	5 kW	500 Vdc	500 Adc	Floor-standing	6.0 Vdc
ALx5-1000-150	5 kW	1000 Vdc	150 Adc	Floor-standing	7.5 Vdc
ALx7.5-200-1800	7.5 kW	200 Vdc	1800 Adc	Floor-standing	2.5 Vdc
ALx7.5-500-750	7.5 kW	500 Vdc	750 Adc	Floor-standing	6.0 Vdc
ALx7.5-1000-225	7.5 kW	1000 Vdc	225 Adc	Floor-standing	7.5 Vdc
ALx10-200-2400	10 kW	200 Vdc	2400 Adc	Floor-standing	2.5 Vdc
ALx10-500-1000	10 kW	500 Vdc	1000 Adc	Floor-standing	6.0 Vdc
ALx10-1000-300	10 kW	1000 Vdc	300 Adc	Floor-standing	7.5 Vdc
ALx12.5-200-3000	12.5 kW	200 Vdc	3000 Adc	Floor-standing	2.5 Vdc
ALx12.5-500-1250	12.5 kW	500 Vdc	1250 Adc	Floor-standing	6.0 Vdc
ALx12.5-1000-375	12.5 kW	1000 Vdc	375 Adc	Floor-standing	7.5 Vdc
ALx15-200-3600	15 kW	200 Vdc	3600 Adc	Floor-standing	2.5 Vdc
ALx15-500-1500	15 kW	500 Vdc	1500 Adc	Floor-standing	6.0 Vdc
ALx15-1000-450	15 kW	1000 Vdc	450 Adc	Floor-standing	7.5 Vdc
ALx17.5-200-4200	17.5 kW	200 Vdc	4200 Adc	Floor-standing	2.5 Vdc
ALx17.5-500-1750	17.5 kW	500 Vdc	1750 Adc	Floor-standing	6.0 Vdc
ALx17.5-1000-525	17.5 kW	1000 Vdc	525 Adc	Floor-standing	7.5 Vdc
ALx20-200-4800	20 kW	200 Vdc	4800 Adc	Floor-standing	2.5 Vdc
ALx20-500-2000	20 kW	500 Vdc	2000 Adc	Floor-standing	6.0 Vdc
ALx20-1000-600	20 kW	1000 Vdc	600 Adc	Floor-standing	7.5 Vdc

Specifications

Power Specifications

AC Input Voltage 1.25 kW to 2.5 kW Models	85 to 265 Vac (UI: Universal Input) 1 Φ , 2-wire + ground
AC Input Voltage 5 kW to 20 kW Models	120 Vac (120SP: operating range 108 to 132 Vac) 240 Vac (240SP: operating range 216 to 264 Vac) 1 Φ , 2-wire + ground
AC Input Frequency	45-66 Hz
AC Input Isolation	\pm 1500 Vac, maximum AC input voltage to ground
DC Input Isolation	\pm 1500 Vdc, maximum DC input voltage to ground

Programming Specifications

Resolution (All Modes)	16-bit, 0.0015%
Accuracy	Voltage: \pm 0.1% of full scale voltage rating Current: \pm 0.2% of full scale current rating Power: \pm 0.3% of full scale power rating Resistance: \pm 0.3% of full scale resistance rating
Rise/Fall Time Maximum	Voltage Mode: 100 ms, 10% to 90% max voltage Current Mode: 560 μ s, 10% to 90% max current Power Mode: 35 ms, 10% to 90% max power Resistance Mode: 40 ms, 10% to 90% max res.
Trip Settings Range	Over Voltage: 10% to 110% of max voltage rating Under Voltage: 0% to 110% of max voltage rating Over Current: 10% to 110% of max current rating Over Power: 10% to 110% of max power rating

Connectivity Specifications

Communication Interfaces (Standard)	USB Host (Front): Type B USB Host (Rear): Type B RS485 (Rear): RJ-45 MagnaLINK™: RJ-25 x 2 External User I/O: 25-pin D-Sub, female
Communication Interfaces (Optional)	LXI TCP/IP Ethernet (Rear): RJ-45 GPIB (Rear): IEEE-488

External User I/O Specifications

Digital Inputs	5 V, 10 k Ω impedance
Digital Monitoring Signals	5 V, 32 mA capacity
Digital Reference Signals	5 V output, 20 mA capacity
Analog Sampling Rate	2 kHz
Analog Programming Input	0-10 V
Analog Programming Impedance	10 k Ω
Analog Programming Resolution	12-bit, 0.025%
Analog Monitoring Signals	0-10 V, 3 mA capacity
Analog Monitoring Impedance	0.005 Ω
Analog Monitoring Accuracy	0.05% of max rating
Analog Reference Signal	10 V, 20 mA capacity

Physical Specifications

Power Level	Rack Units	Size	Weight
1.25 kW	3U	5.25" H x 19" W x 24" D (13.34 x 48.26 x 60.96 cm)	40 lbs (18.1 kg)
2.5 kW	3U	5.25" H x 19" W x 24" D (13.34 x 48.26 x 60.96 cm)	65 lbs (29.5 kg)
5 kW	12U Cabinet	30.7" H x 24" W x 31.5" D (78.0 x 61.0 x 80.0 cm)	255 lbs (115.7 kg)
7.5 kW	12U Cabinet	30.7" H x 24" W x 31.5" D (78.0 x 61.0 x 80.0 cm)	320 lbs (145.2 kg)
10 kW	12U Cabinet	30.7" H x 24" W x 31.5" D (78.0 x 61.0 x 80.0 cm)	385 lbs (174.6 kg)
12.5 kW	24U Cabinet	58.25" H x 24" W x 31.5" D (148.0 x 61.0 x 80.0 cm)	500 lbs (226.8 kg)
15 kW	24U Cabinet	58.25" H x 24" W x 31.5" D (148.0 x 61.0 x 80.0 cm)	565 lbs (256.3 kg)
17.5 kW	24U Cabinet	58.25" H x 24" W x 31.5" D (148.0 x 61.0 x 80.0 cm)	630 lbs (285.8 kg)
20 kW	24U Cabinet	58.25" H x 24" W x 31.5" D (148.0 x 61.0 x 80.0 cm)	695 lbs (315.3 kg)

Environmental Specifications

Ambient Operating Temperature	0°C to 50°C
Storage Temperature	-25°C to +85°C
Humidity	Relative humidity up to 95% non-condensing
Air Flow	Front air inlet, rear exhaust

Regulatory Compliance

EMC	Complies with European EMC Directive for test and measurement products, 2014/30/EU
Safety	Complies with EN61010-1:2010-02
CE Mark	Yes
RoHS Compliant	Yes

ALx Series Model Ordering Guide

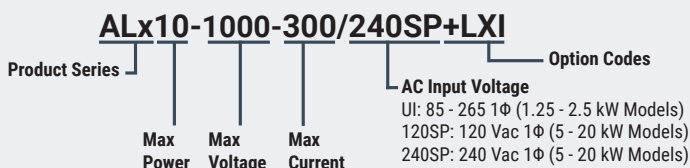

ALx Series

DC Electronic Load • Air cooled, linear MOSFET topology, wide operating range

Product Diagrams

Front Panel 1.25 kW and 2.5 kW Models

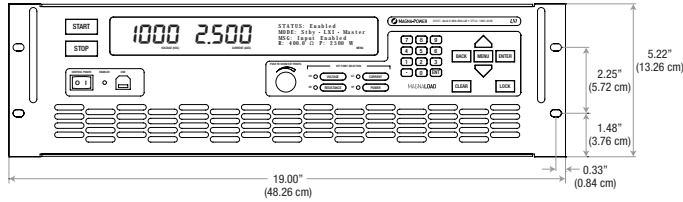

Rear Panel 1.25 kW and 2.5 kW Models

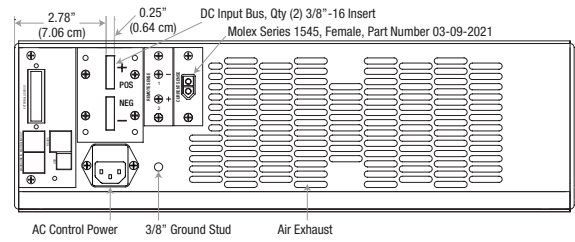

Side Panel 1.25 kW and 2.5 kW Models

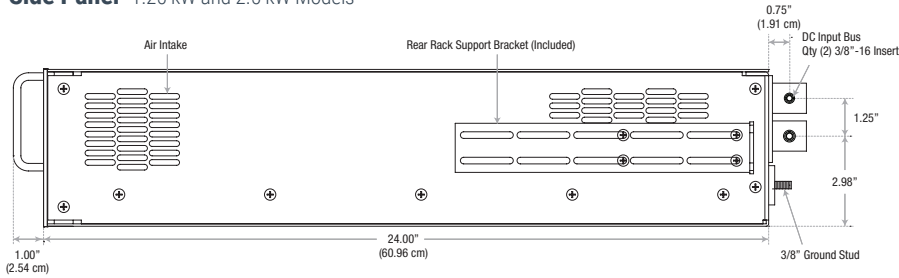

Front Side 5 kW to 20 kW Models

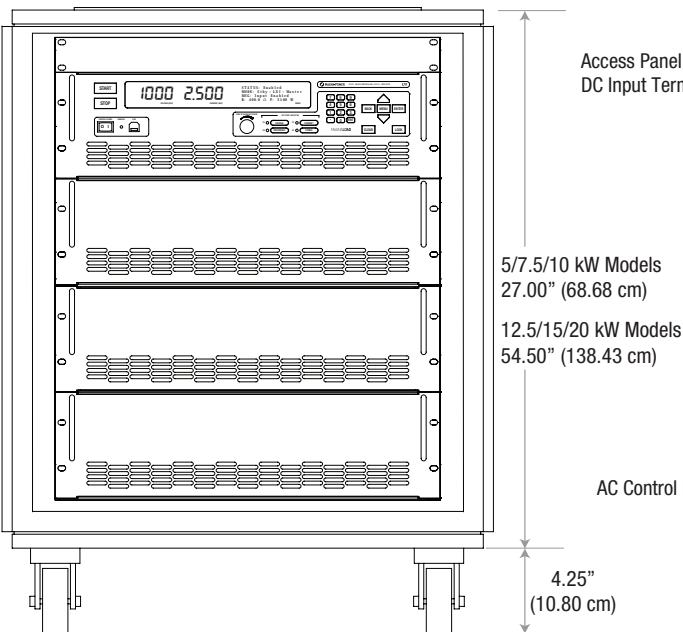

Rear Side 5 kW to 20 kW Models

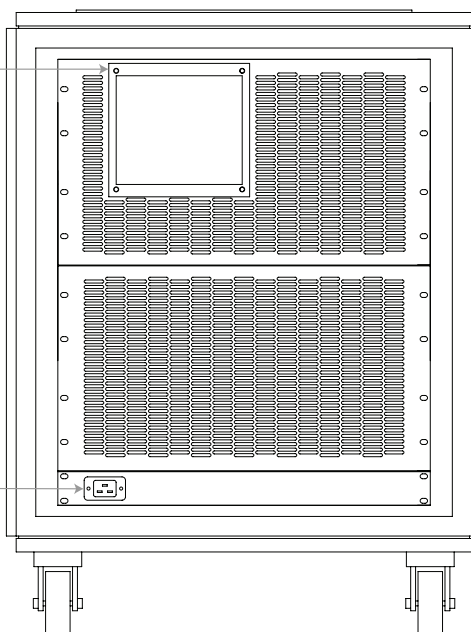

Operating Profiles

With its sole use of linear elements for heat dissipation, the ALx Series has the widest operating profile of the MagnaLOAD products. This operating profile figure applies to all ALx Series models, normalized about the model's maximum voltage, current, and power ratings.

200 Vdc ALx Series Models

ALx Series MagnaLOAD Normalized Operating Profile - 200 Vdc Models

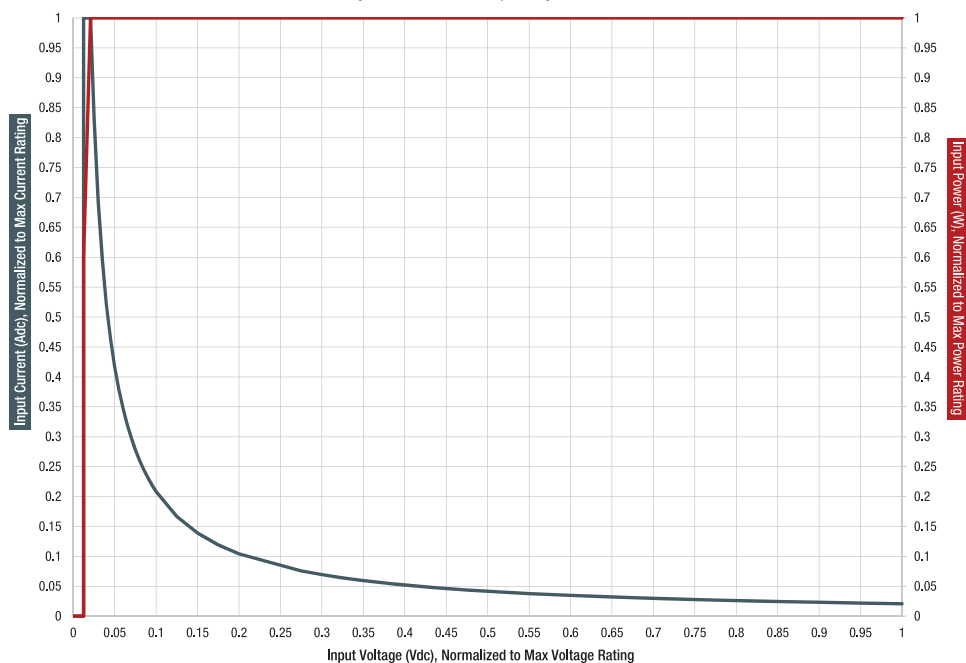

500 Vdc ALx Series Models

ALx Series MagnaLOAD Normalized Operating Profile - 500 Vdc Models

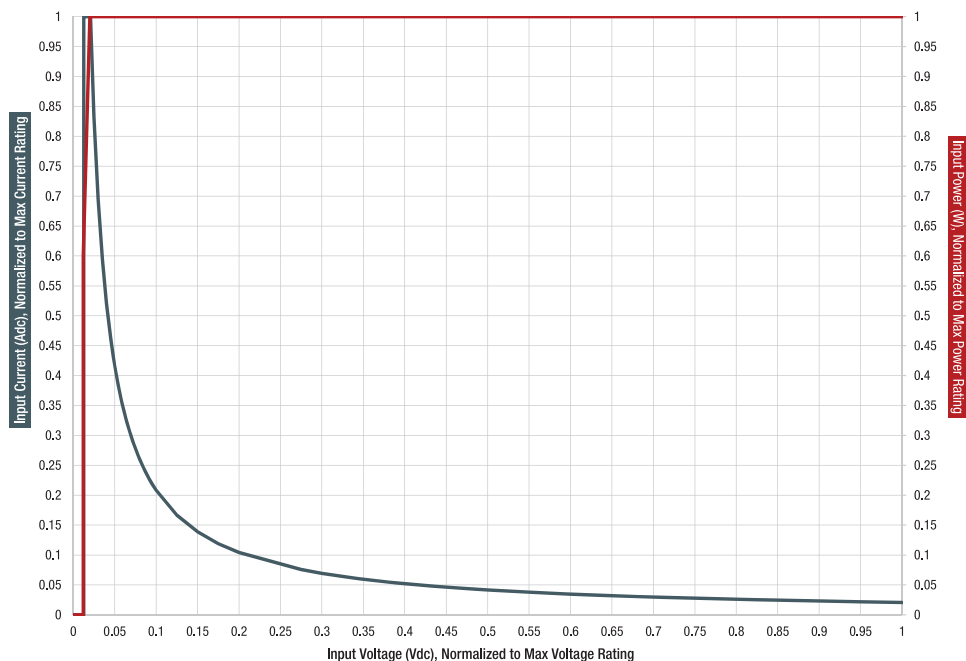

ALx Series

DC Electronic Load • Air cooled, linear MOSFET topology, wide operating range

Operating Profiles, Continued

1000 Vdc ALx Series Models

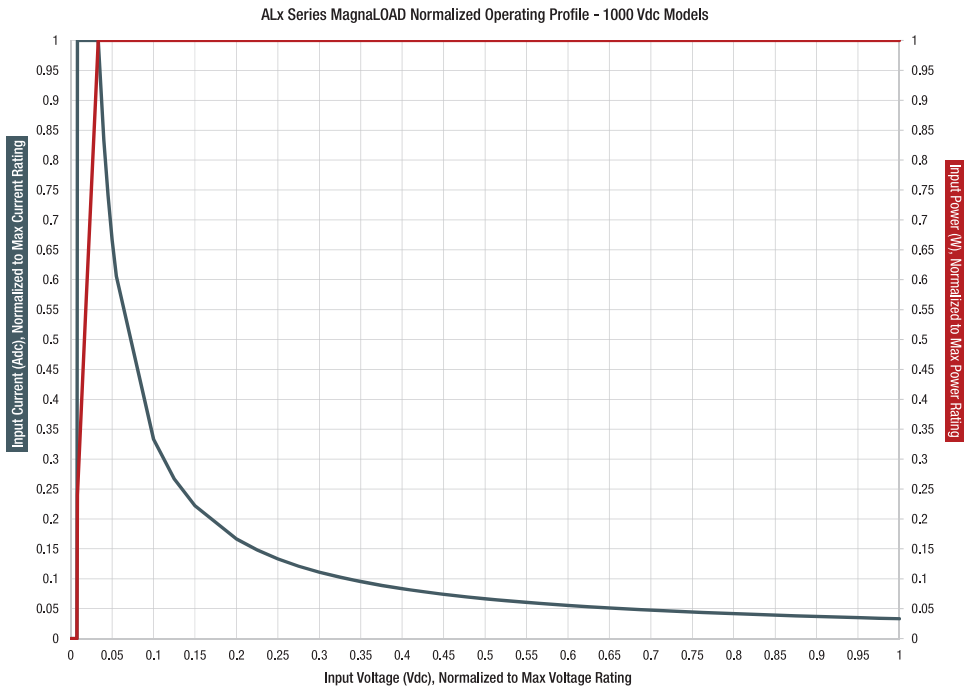



ARx Series

DC Electronic Load • Air cooled, Active Resistance Technology



Overview

Magna-Power's patented Active Resistance Technology (US Patent 9,429,629) is a completely new approach to electronic loads. By utilizing a switched binary matrix of resistances and MOSFET network, combined with Magna-Power's new MagnaLINK™ distributed DSP architecture, the ARx Series delivers the same features and performance as traditional electronic loads, at a fraction of the price. In addition to the 16-bit precision voltage, current, resistance, power, and shunt regulator control modes, the ARx Series also provides a rheostat control mode, allowing direct control of the product's internal resistance network.

Finally, an electronic load control mode with no bandwidth constraint for true step load response.

Technology

The ARx Series utilizes Active Resistance Technology to deliver performance consistent with conventional electronic loads, but at a fraction of the price and with the ability to directly switch passive resistors on-the-fly.

In Magna-Power's Active Resistive Technology, switched resistors are placed in series with MOSFETs. High-performance DSPs simultaneously control both dissipation elements in harmony. Assuming the power across the shunt resistor is insignificant, the power dissipated in load resistor R1 is $I_L \times V_{R1}$ and the power dissipated in MOSFET Q1 is $I_L \times V_{Q1}$. The resistors can be operated at higher temperatures than the MOSFETs, simplifying cooling requirements of the passive elements. Keeping V_{Q1} small and V_{R1} large lowers system costs in comparison with purely semiconductor electronic loads. Adjusting the value of resistor R1 is accomplished with a binary switching matrix. Finally, keeping the resistor switching increments small and over a wide range maintains the smallest voltages across the linear modules and over the widest operating range.

The advantage of resistive loads are reliability and cost per watt for dissipating power, while the advantage of MOSFET loads is speed of performance and the ability to dissipate power over a wide operating range. Active Resistive Technology blends switched resistance with MOSFETs to significantly lower the product's cost, add new control modes, while still delivering 16-bit precision and high-accuracy performance.

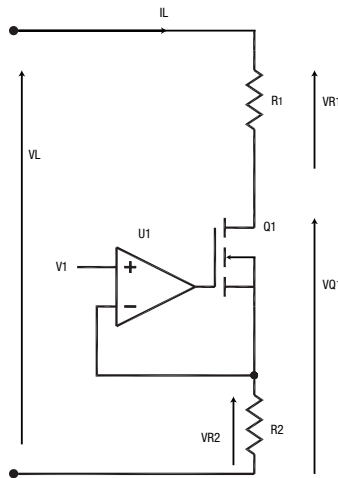

Key Features

- MagnaLINK™ Distributed DSP Architecture
- 16-bit digital programming and monitoring resolution
- SCPI Remote Programming API
- Many control modes, including: voltage, current, power, resistance, shunt regulator and rheostat
- Multiple operating ranges
- Integrated front and rear full control USB ports, RS485, and dual MagnaLINK™ ports, with LXI TCP/IP Ethernet and IEEE-488 GPIB available.
- Digital plug-and-play master-slaving
- Programmable protection limits
- Configurable external analog-digital user I/O
- Designed and manufactured in the USA

Rheostat Mode

Rheostat Mode, one of six available control modes, bypasses the linear elements to provide direct on-the-fly control of the MagnaLOAD's switched resistor matrix for true step load response. A total of 31 different resistor states are available. Each resistor state has an associated power limit, less than the MagnaLOAD's full scale rated power, which cannot be exceeded. Resistor states can be switched on-the-fly, with the DC input enabled, at the resistor state's maximum power rating. The full scale rated output voltage or full scale rated output current can be achieved at each resistor state, as long as that resistor state's power limit is not exceeded.

The 31 available Rheostat resistance values vary by model. For a single resistor state on a specific model, the resistance value is calculated as:

$$(\text{Reference Resistor Value}) \times (\text{Resistor Multiplier})$$

Refer to the User Manual for each model's resistor parameters.

Models

Model	Maximum Power	Maximum Voltage	Maximum Current	Package Type	Minimum Voltage
ARx6.75-100-140	6.75 kW	100 Vdc	140 Adc	Rack-mount	2.0 Vdc
ARx6.75-200-70	6.75 kW	200 Vdc	70 Adc	Rack-mount	2.5 Vdc
ARx6.75-500-28	6.75 kW	500 Vdc	28 Adc	Rack-mount	3.0 Vdc
ARx6.75-1000-14	6.75 kW	1000 Vdc	14 Adc	Rack-mount	5.0 Vdc
ARx13.5-100-280	13.5 kW	100 Vdc	280 Adc	Floor-standing	2.0 Vdc
ARx13.5-200-140	13.5 kW	200 Vdc	140 Adc	Floor-standing	2.5 Vdc
ARx13.5-500-56	13.5 kW	500 Vdc	56 Adc	Floor-standing	3.0 Vdc
ARx13.5-1000-28	13.5 kW	1000 Vdc	28 Adc	Floor-standing	5.0 Vdc
ARx20.25-100-420	20.25 kW	100 Vdc	420 Adc	Floor-standing	2.0 Vdc
ARx20.25-200-210	20.25 kW	200 Vdc	210 Adc	Floor-standing	2.5 Vdc
ARx20.25-500-84	20.25 kW	500 Vdc	84 Adc	Floor-standing	3.0 Vdc
ARx20.25-1000-42	20.25 kW	1000 Vdc	42 Adc	Floor-standing	5.0 Vdc
ARx27-100-560	27 kW	100 Vdc	560 Adc	Floor-standing	2.0 Vdc
ARx27-200-280	27 kW	200 Vdc	280 Adc	Floor-standing	2.5 Vdc
ARx27-500-112	27 kW	500 Vdc	112 Adc	Floor-standing	3.0 Vdc
ARx27-1000-56	27 kW	1000 Vdc	56 Adc	Floor-standing	5.0 Vdc
ARx33.75-100-700	33.75 kW	100 Vdc	700 Adc	Floor-standing	2.0 Vdc
ARx33.75-200-350	33.75 kW	200 Vdc	350 Adc	Floor-standing	2.5 Vdc
ARx33.75-500-140	33.75 kW	500 Vdc	140 Adc	Floor-standing	3.0 Vdc
ARx33.75-1000-70	33.75 kW	1000 Vdc	70 Adc	Floor-standing	5.0 Vdc
ARx40.5-100-840	40.5 kW	100 Vdc	840 Adc	Floor-standing	2.0 Vdc
ARx40.5-200-420	40.5 kW	200 Vdc	420 Adc	Floor-standing	2.5 Vdc
ARx40.5-500-168	40.5 kW	500 Vdc	168 Adc	Floor-standing	3.0 Vdc
ARx40.5-1000-84	40.5 kW	1000 Vdc	84 Adc	Floor-standing	5.0 Vdc

Specifications

Power Specifications

AC Input Voltage 6.75 kW Models	85 to 265 Vac (UI: Universal Input) 1 Φ , 2-wire + ground
AC Input Voltage 13.5 kW to 27 kW Models	120 Vac (120SP: operating range 108 to 132 Vac) 240 Vac (240SP: operating range 216 to 264 Vac) 1 Φ , 2-wire + ground
AC Input Voltage 33.75 kW and 40.5 kW Models	240 Vac (240SP: operating range 216 to 264 Vac) 1 Φ , 2-wire + ground
AC Input Frequency	45-66 Hz
AC Input Isolation	\pm 1500 Vac, maximum AC input voltage to ground
DC Input Isolation	\pm 1500 Vdc, maximum DC input voltage to ground

Programming Specifications

Resolution (All Modes)	16-bit, 0.0015%
Accuracy	Voltage: \pm 0.1% of max voltage rating Current: \pm 0.2% of max current rating Power: \pm 0.3% of max power rating Resistance: \pm 0.3% of max resistance rating
Rise/Fall Time Maximum	Voltage Mode: 100 ms, 10% to 90% max voltage Current Mode: 560 μ s, 10% to 90% max current Power Mode: 35 ms, 10% to 90% max power Resistance Mode: 40 ms, 10% to 90% max res. Rheostat Mode: Instantaneous load step
Trip Settings Range	Over Voltage: 10% to 110% of max voltage rating Under Voltage: 0% to 110% of max voltage rating Over Current: 10% to 110% of max current rating Over Power: 10% to 110% of max power rating

Connectivity Specifications

Communication Interfaces (Standard)	USB Host (Front): Type B USB Host (Rear): Type B RS485 (Rear): RJ-45 MagnaLINK™: RJ-25 x 2 External User I/O: 25-pin D-Sub, Female
Communication Interfaces (Optional)	LXI TCP/IP Ethernet (Rear): RJ-45 GPIB (Rear): IEEE-488

Environmental Specifications

Ambient Operating Temperature	0°C to 50°C
Storage Temperature	-25°C to +85°C
Humidity	Relative humidity up to 95% non-condensing
Air Flow	Front air inlet, rear exhaust

External User I/O Specifications

Digital Inputs	5 V, 10 k Ω impedance
Digital Monitoring Signals	5 V, 32 mA capacity
Digital Reference Signals	5 V output, 20 mA capacity
Analog Sampling Rate	2 kHz
Analog Programming Input	0-10 V
Analog Programming Impedance	10 k Ω
Analog Programming Resolution	12-bit, 0.025%
Analog Monitoring Signals	0-10 V, 3 mA capacity
Analog Monitoring Impedance	0.005 Ω
Analog Monitoring Accuracy	0.05% of max rating
Analog Reference Signal	10 V, 20 mA capacity

Physical Specifications

Power Level	Rack Units	Size	Weight
6.75 kW	6U	10" H x 19" W x 24" D (26.67 x 48.26 x 60.96 cm)	125 lbs (56.7 kg)
13.5 kW	12U Cabinet	30.7" H x 24" W x 31.5" D (78.0 x 61.0 x 80.0 cm)	315 lbs (142.9 kg)
20.25 kW	24U Cabinet	58.25" H x 24" W x 31.5" D (148.0 x 61.0 x 80.0 cm)	440 lbs (199.6 kg)
27 kW	24U Cabinet	58.25" H x 24" W x 31.5" D (148.0 x 61.0 x 80.0 cm)	565 lbs (256.3 kg)
33.75 kW	36U Cabinet	74" H x 24" W x 31.5" D (188.0 x 61.0 x 80.0 cm)	690 lbs (313.0 kg)
40.5 kW	36U Cabinet	74" H x 24" W x 31.5" D (188.0 x 61.0 x 80.0 cm)	815 lbs (369.7 kg)

Regulatory Compliance

EMC	Complies with European EMC Directive for test and measurement products, 2014/30/EU
Safety	Complies with EN61010-1:2010-02
CE Mark	Yes
RoHS Compliant	Yes

ARx Series Model Ordering Guide

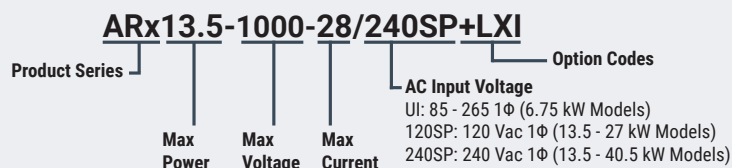

ARx Series

DC Electronic Load • Air cooled, Active Resistance Technology

Operating Ranges

With its combination of resistor and linear elements, the ARx Series DC electronic load provides two distinct operating ranges: High Power Range and Low Power Range. The operating range can be selected from the front panel or by computer command.

The operating ranges figures below apply to all ARx Series models, normalized about the model's maximum voltage, current, and power ratings.

High Power Range

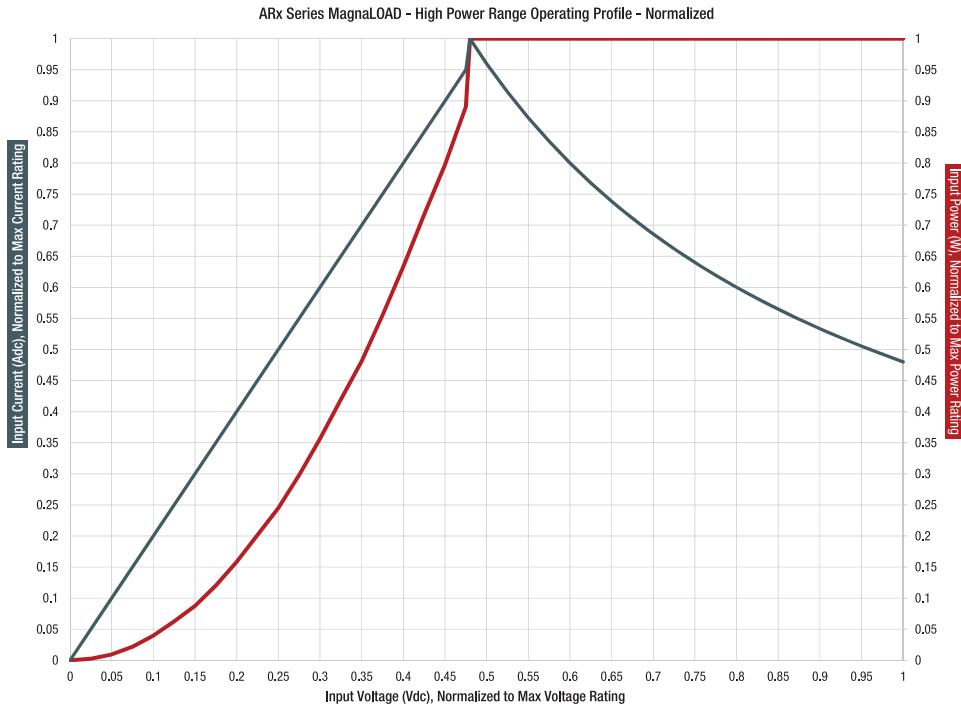

Understanding the High Power Operating Range

The chart on the left normalizes the High Power Operating range about the product's maximum voltage, current and power ratings.

The High Power Range allows the ARx Series MagnaLOAD to operate up to its maximum power rating over the range of 48% to 100% of the product's maximum voltage rating (shown by the light blue series). Below 48% of the product's maximum voltage rating, the current available decays linearly (shown by the dark blue series).

Low Power Range

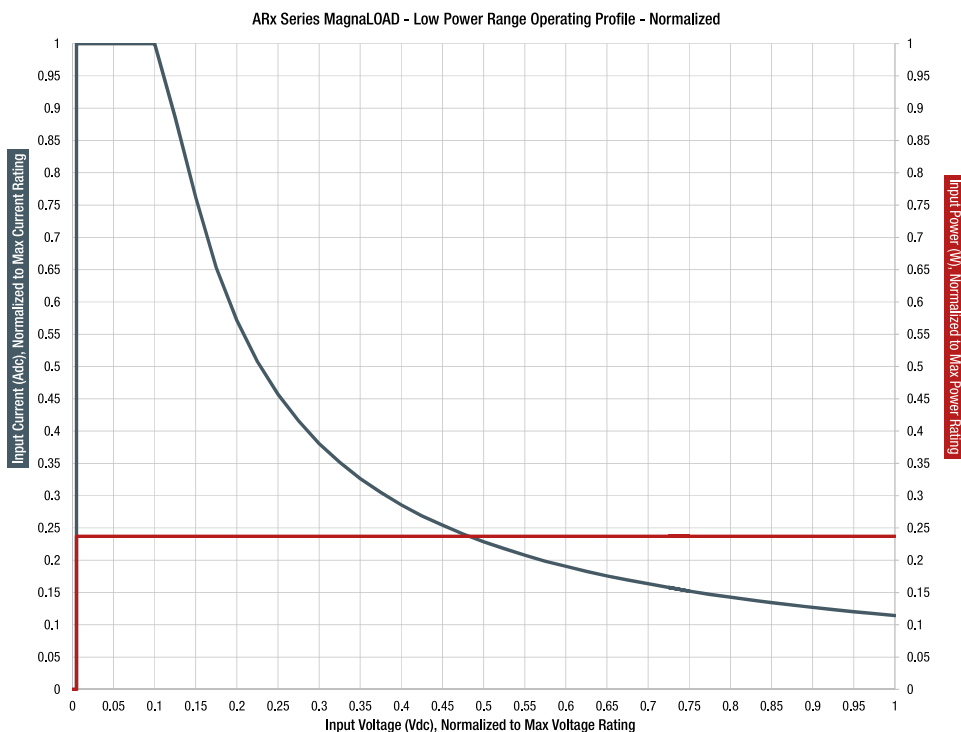

Understanding the Low Power Operating Range

The chart on the left normalizes the Low Power Operating range about the product's maximum voltage, current and power ratings.

The Low Power Range allows the ARx Series MagnaLOAD to operate at the full current rating from the product's minimum voltage rating to 10% of the product's maximum voltage rating. Above 10% of the maximum voltage rating, the unit is limited to just over 20% of the maximum power rating, so the available current falls as a function of voltage.

Product Diagrams

Front Panel 6.75 kW Models

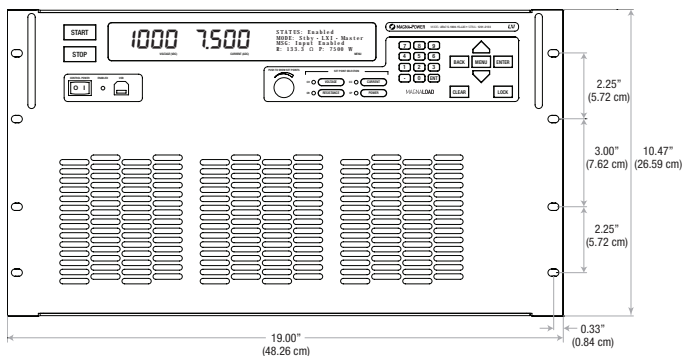

Rear Panel 6.75 kW Models

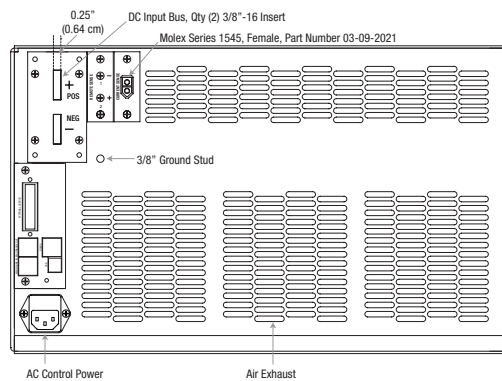

Side Panel 6.75 kW Models

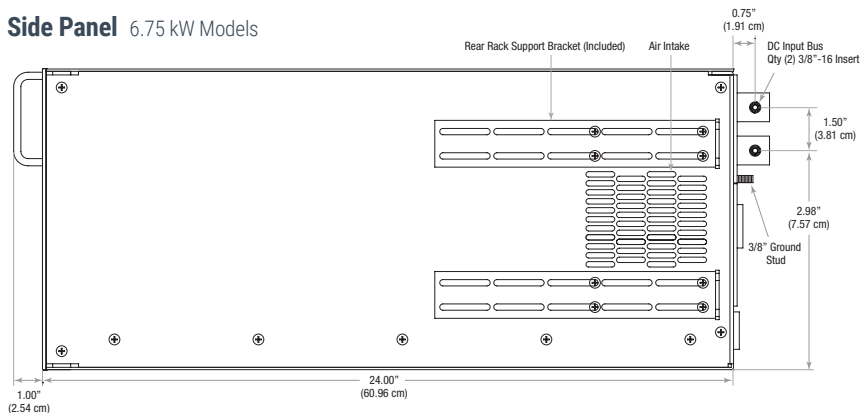

Front Side 13.5 kW to 40.5 kW Models

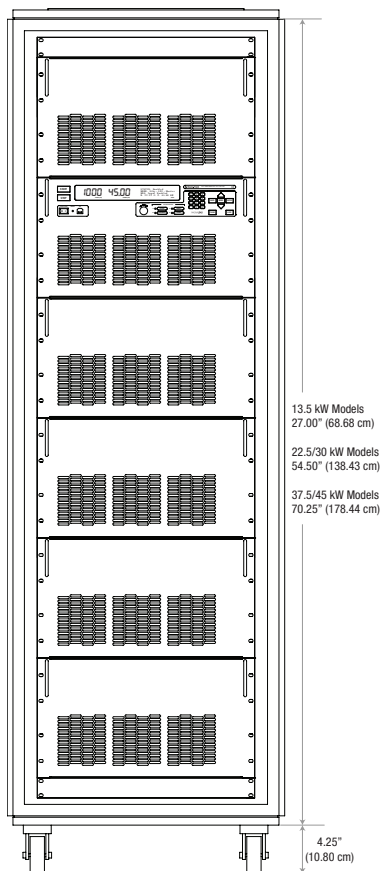

Rear Side 13.5 kW to 40.5 kW Models

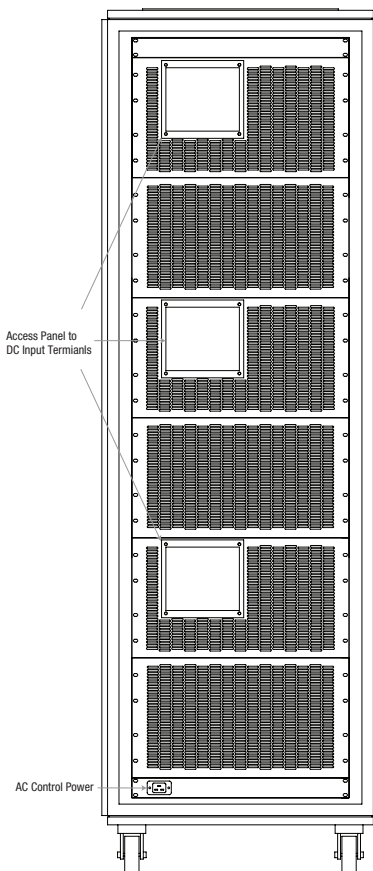

DC Input Bus 13.5 kW to 40.5 kW Models

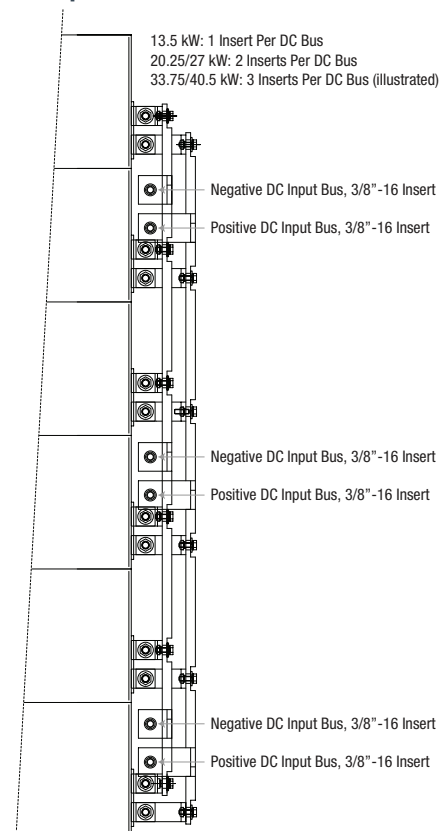

WRx Series

DC Electronic Load • Water cooled, Active Resistance Technology



Overview

Utilizing Magna-Power's patented Active Resistance Technology (US Patent 9,429,629) in combination with the company's internally manufactured microchannel water-cooled heatsinks, the WRx Series addresses high power DC applications where exhaust heat control is essential. The WRx Series greatly increases power density compared air-cooled alternatives. An integrated solenoid controls the flow of water to avoid condensation. Full power can be achieved using conventional water, with water inlet temperatures up to 25°C.

Magna-Power's Active Resistance Technology utilizes a switched binary matrix of resistances and MOSFET network, combined with Magna-Power's new MagnaLINK™ distributed DSP architecture, the WRx Series delivers the same features and performance as traditional electronic loads, at a fraction of the price. In addition to the 16-bit precision voltage, current, resistance, power, and shunt regulator control modes, the WRx Series also provides a rheostat control mode, allowing direct control of the product's internal resistance network.

Technology

The WRx Series utilizes Active Resistance Technology to deliver performance consistent with conventional electronic loads, but at a fraction of the price and with the ability to directly switch passive resistors on-the-fly.

In Magna-Power's Active Resistive Technology, switched resistors are placed in series with MOSFETs. High-performance DSPs simultaneously control both dissipation elements in harmony. Assuming the power across the shunt resistor is insignificant, the power dissipated in load resistor R1 is $I_L \times V_{R1}$ and the power dissipated in MOSFET Q1 is $I_L \times V_{Q1}$. The resistors can be operated at higher temperatures than the MOSFETs, simplifying cooling requirements of the passive elements. Keeping V_{Q1} small and V_{R1} large lowers system costs in comparison with purely semiconductor electronic loads. Adjusting the value of resistor R1 is accomplished with a binary switching matrix. Finally, keeping the resistor switching increments small and over a wide range maintains the smallest voltages across the linear modules and over the widest operating range.

The advantage of resistive loads are reliability and cost per watt for dissipating power, while the advantage of MOSFET loads is speed of performance and the ability to dissipate power over a wide operating range. Active Resistive Technology blends switched resistance with MOSFETs to significantly lower the product's cost, add new control modes, while still delivering 16-bit precision and high-accuracy performance.

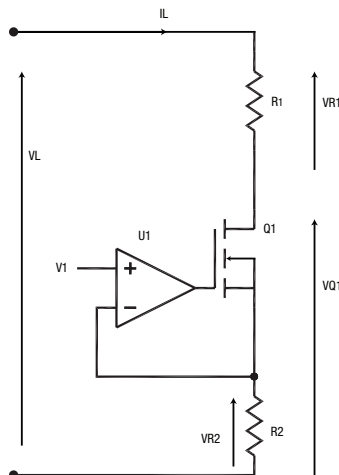

Key Features

- MagnaLINK™ Distributed DSP Architecture
- 16-bit digital programming and monitoring resolution
- SCPI Remote Programming API
- Many control modes, including: voltage, current, power, resistance, shunt regulator and rheostat
- Multiple operating ranges
- Integrated front and rear full control USB ports, RS485, and dual MagnaLINK™ ports, with LXI TCP/IP Ethernet and IEEE-488 GPIB available.
- Digital plug-and-play master-slaving
- Programmable protection limits
- Configurable external analog-digital user I/O
- Designed and manufactured in the USA

Rheostat Mode

Rheostat Mode, one of six available control modes, bypasses the linear elements to provide direct on-the-fly control of the MagnaLOAD's switched resistor matrix for true step load response. A total of 31 different resistor states are available. Each resistor state has an associated power limit, less than the MagnaLOAD's full scale rated power, which cannot be exceeded. Resistor states can be switched on-the-fly, with the DC input enabled, at the resistor state's maximum power rating. The full scale rated output voltage or full scale rated output current can be achieved at each resistor state, as long as that resistor state's power limit is not exceeded.

The 31 available Rheostat resistance values vary by model. For a single resistor state on a specific model, the resistance value is calculated as:

(Reference Resistor Value) x (Resistor Multiplier)

Refer to the User Manual for each model's resistor parameters.

Models

Model	Maximum Power	Maximum Voltage	Maximum Current	Package Type	Minimum Voltage
WRx12.5-200-130	12.5 kW	200 Vdc	130 Adc	Rack-mount	2.5 Vdc
WRx12.5-500-52	12.5 kW	500 Vdc	52 Adc	Rack-mount	3.0 Vdc
WRx12.5-1000-26	12.5 kW	1000 Vdc	26 Adc	Rack-mount	5.0 Vdc
WRx25-200-260	25 kW	200 Vdc	260 Adc	Floor-standing	2.5 Vdc
WRx25-500-104	25 kW	500 Vdc	104 Adc	Floor-standing	3.0 Vdc
WRx25-1000-52	25 kW	1000 Vdc	52 Adc	Floor-standing	5.0 Vdc
WRx50-200-520	50 kW	200 Vdc	520 Adc	Floor-standing	2.5 Vdc
WRx50-500-208	50 kW	500 Vdc	208 Adc	Floor-standing	3.0 Vdc
WRx50-1000-104	50 kW	1000 Vdc	104 Adc	Floor-standing	5.0 Vdc
WRx75-200-780	75 kW	200 Vdc	780 Adc	Floor-standing	2.5 Vdc
WRx75-500-312	75 kW	500 Vdc	312 Adc	Floor-standing	3.0 Vdc
WRx75-1000-156	75 kW	1000 Vdc	156 Adc	Floor-standing	5.0 Vdc
WRx100-200-1040	100 kW	200 Vdc	1040 Adc	Floor-standing	2.5 Vdc
WRx100-500-416	100 kW	500 Vdc	416 Adc	Floor-standing	3.0 Vdc
WRx100-1000-208	100 kW	1000 Vdc	208 Adc	Floor-standing	5.0 Vdc

Specifications

AC Input Specifications

AC Input Voltage 12.5 kW Models	85 to 265 Vac (UI: Universal Input) 1 Φ , 2-wire + ground
AC Input Voltage 25 kW to 75 kW Models	120 Vac (120SP: operating range 108 to 132 Vac) 240 Vac (240SP: operating range 216 to 264 Vac) 1 Φ , 2-wire + ground
AC Input Voltage 100 kW Models	240 Vac (240SP: operating range 216 to 264 Vac) 1 Φ , 2-wire + ground
AC Input Frequency	45-66 Hz
AC Input Isolation	\pm 1500 Vac, maximum AC input voltage to ground
DC Input Isolation	\pm 1500 Vdc, maximum DC input voltage to ground

Programming Specifications

Resolution (All Modes)	16-bit, 0.0015%
Accuracy	Voltage: \pm 0.1% of full scale voltage rating Current: \pm 0.2% of full scale current rating Power: \pm 0.3% of full scale power rating Resistance: \pm 0.3% of full scale resistance rating
Rise/Fall Time Maximum	Voltage Mode: 100 ms, 10% to 90% max voltage Current Mode: 560 μ s, 10% to 90% max current Power Mode: 35 ms, 10% to 90% max power Resistance Mode: 40 ms, 10% to 90% max res. Rheostat Mode: Instantaneous load step
Trip Settings Range	Over Voltage: 10% to 110% of max voltage rating Under Voltage: 0% to 110% of max voltage rating Over Current: 10% to 110% of max current rating Over Power: 10% to 110% of max power rating

Connectivity Specifications

Communication Interfaces (Standard)	USB Host (Front): Type B USB Host (Rear): Type B RS485 (Rear): RJ-45 MagnaLINK™: RJ-25 x 2 External User I/O: 25-pin D-Sub, female
Communication Interfaces (Optional)	LXI TCP/IP Ethernet (Rear): RJ-45 GPIB (Rear): IEEE-488

Water Cooling Specifications

Water Connection Provided 12.5 kW Models	1/2" NPT male inlet and outlet
Water Connection Provided 25 kW to 100 kW Models	1" NPT male inlet and outlet
Maximum Inlet Temperature	25°C
Maximum Inlet Pressure	80 PSI
Minimum Flow Rate	12.5 kW Models: 1.5 GPM 25 kW Models: 3.0 GPM 50 kW Models: 6.0 GPM 75 kW Models: 9.0 GPM 100 kW Models: 12.0 GPM

Environmental Specifications

Ambient Operating Temperature	0°C to 50°C
Storage Temperature	-25°C to +85°C
Humidity	Relative humidity up to 95% non-condensing
Air Flow	Front air inlet, rear exhaust

External User I/O Specifications

Digital Inputs	5 V, 10 k Ω impedance
Digital Monitoring Signals	5 V, 32 mA capacity
Digital Reference Signals	5 V output, 20 mA capacity
Analog Sampling Rate	2 kHz
Analog Programming Input	0-10 V
Analog Programming Impedance	10 k Ω
Analog Programming Resolution	12-bit, 0.025%
Analog Monitoring Signals	0-10 V, 3 mA capacity
Analog Monitoring Impedance	0.005 Ω
Analog Monitoring Accuracy	0.05% of max rating
Analog Reference Signal	10 V, 20 mA capacity

Physical Specifications

Power Level	Rack Units	Size	Weight
12.5 kW	4U	7" H x 24" W x 19" D (17.8 x 60.9 x 48.2 cm)	165 lbs (74.8 kg)
25 kW	12U Cabinet	30.7" H x 24" W x 31.5" D (78.0 x 61.0 x 80.0 cm)	455 lbs (206.4 kg)
50 kW	24U Cabinet	58.25" H x 24" W x 31.5" D (148.0 x 61.0 x 80.0 cm)	785 lbs (356.1 kg)
75 kW	24U Cabinet	58.25" H x 24" W x 31.5" D (148.0 x 61.0 x 80.0 cm)	1115 lbs (505.8 kg)
100 kW	36U Cabinet	74" H x 24" W x 31.5" D (188.0 x 61.0 x 80.0 cm)	1445 lbs (655.4 kg)

Regulatory Compliance

EMC	Complies with European EMC Directive for test and measurement products, 2014/30/EU
Safety	Complies with EN61010-1:2010-02
CE Mark	Yes
RoHS Compliant	Yes

WRx Series Model Ordering Guide

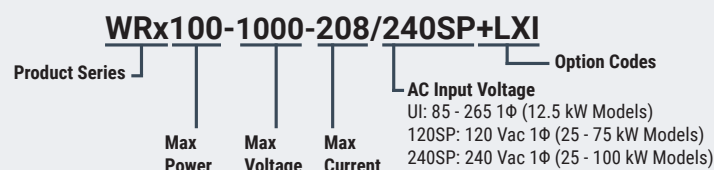

WRx Series

DC Electronic Load • Water cooled, Active Resistance Technology

Operating Ranges

With its combination of resistor and linear elements, the WRx Series DC electronic load provides two distinct operating ranges: High Power Range and Low Power Range. The operating range can be selected from the front panel or by computer command.

The operating ranges figures below apply to all WRx Series models, normalized about the model's maximum voltage, current, and power ratings.

High Power Range

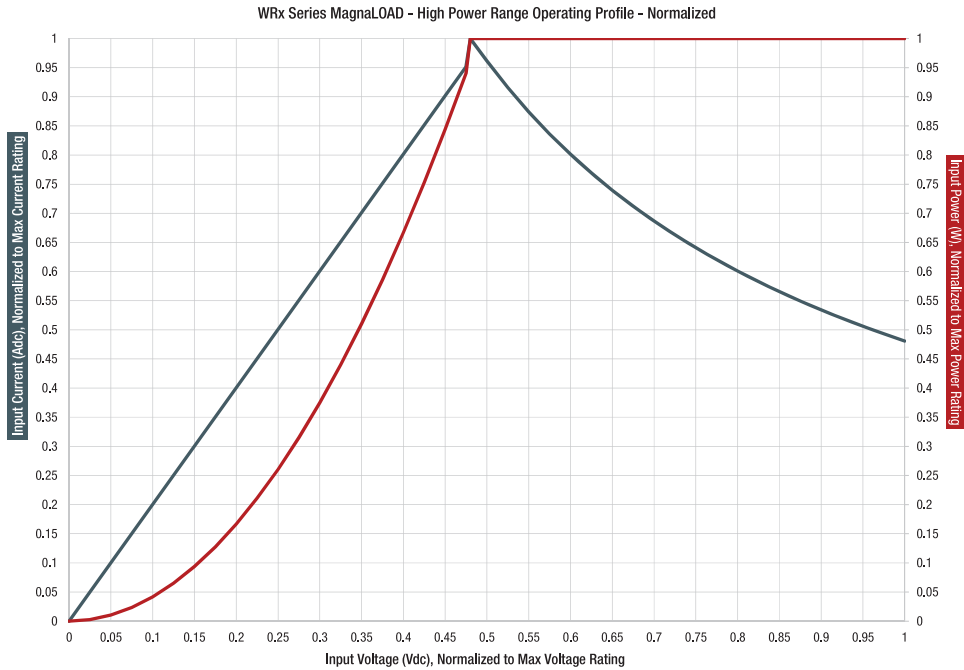

Understanding the High Power Operating Range

The chart on the left normalizes the High Power Operating range about the product's maximum voltage, current and power ratings.

The High Power Range allows the ARx Series MagnaLOAD to operate up to its maximum power rating over the range of 48% to 100% of the product's maximum voltage rating (shown by the light blue series). Below 48% of the product's maximum voltage rating, the current available decays linearly (shown by the dark blue series).

Low Power Range

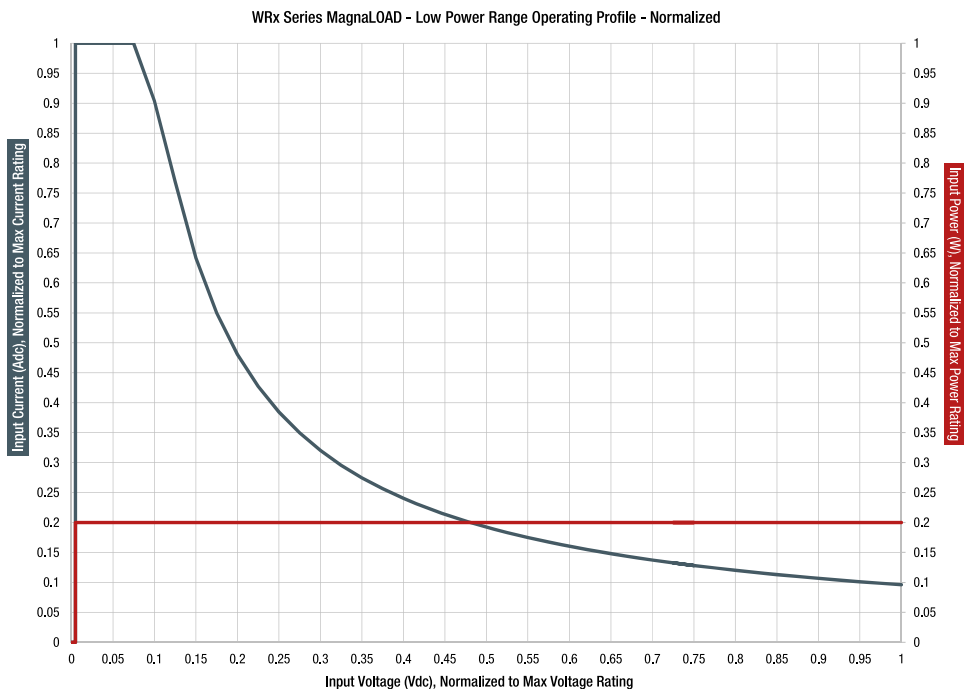

Understanding the Low Power Operating Range

The chart on the left normalizes the Low Power Operating range about the product's maximum voltage, current and power ratings.

The Low Power Range allows the ARx Series MagnaLOAD to operate at the full current rating from the product's minimum voltage rating to 10% of the product's maximum voltage rating. Above 10% of the maximum voltage rating, the unit is limited to just over 20% of the maximum power rating, so the available current falls as a function of voltage.

Product Diagrams

Front Panel 12.5 kW Models

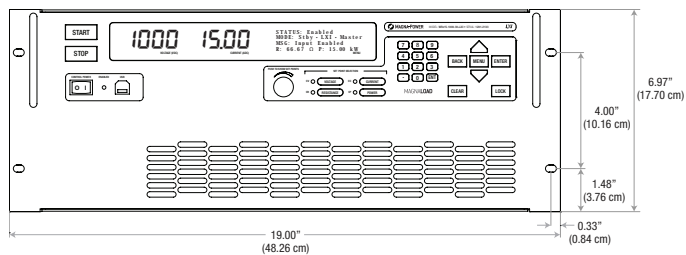

Rear Panel 12.5 kW Models

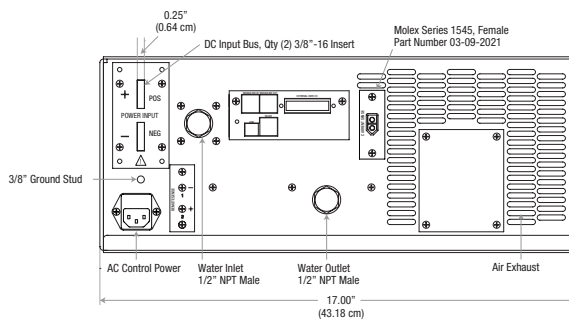

Side Panel 12.5 kW Models

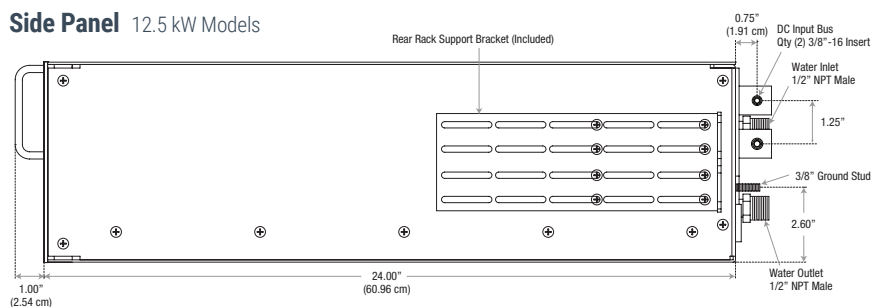

Front Side 25 kW to 100 kW Models

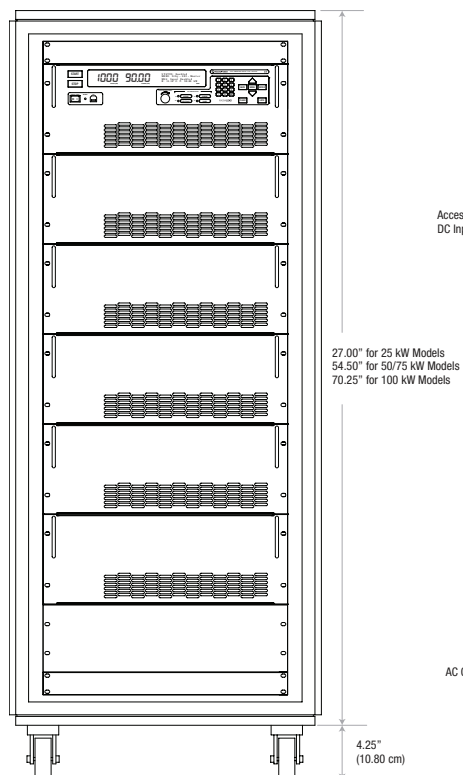

Rear Side 25 kW to 100 kW Models

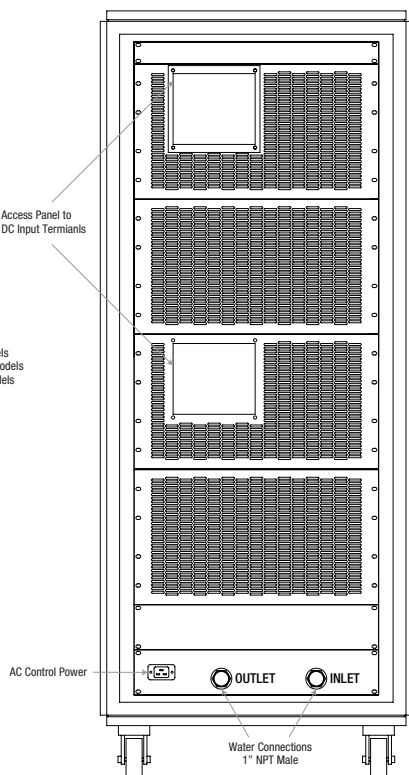

DC Input Bus 25 kW to 100 kW Models

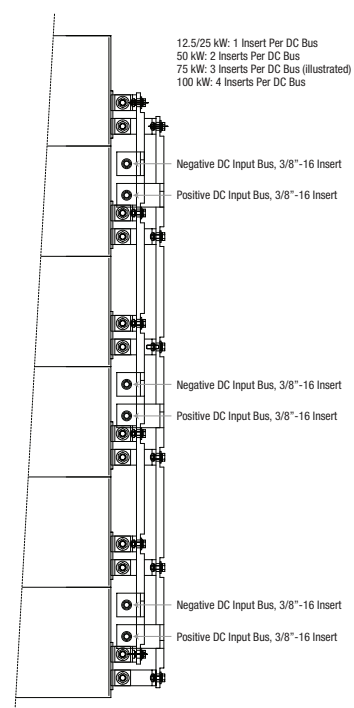





Electronic Loads – A New Generation

DC electronic loads have been available for electronic testing applications for several decades. Today's products range from switched resistors, high speed active loads utilizing power semiconductors, and regenerative loads that return power to the utility. Each technology group has found their way into various applications. This article describes some advantages and disadvantages of the technology alternatives and presents a newly developed, hybrid circuit topology offering some unique performance features.

Switched Resistive Loads

The oldest generation of electronic loads is based on switching of resistive components. Depending on the power level, resistors are commonly constructed from steel plates, nichrome wire, or metal film resistors. Switched resistor loads have the lowest cost per watt, but the poorest performance in terms of dynamic response, programmability, and protection.

Figure 1 shows two circuits that are commonly used with resistive switching. The two configurations differ in their ability to select the desired resistor combination versus the ability to dissipate power.

Figure 1a, binary switching, provides the most accurate resistance selection per quantity of components. Resistor R2 has twice the resistance as resistor R1, R3 has twice the resistance as R2, and so forth. This circuit is often used in low power applications to obtain digital to analog conversion where power is not a consideration. Power varies as the square of applied voltage and as a load, binary switching exhibits poor performance in terms of power dissipation at lower voltage levels. Binary switching is the best choice for applications when the applied voltage is fixed.

Figure 1b, optimized power switching, allows resistors to be placed in series or parallel offering better power dissipation performance over a wider range of applied voltage. The disadvantage, when compared to binary switching, is that optimized power switching has a lower selection of available resistor settings per number of components. With three switches, maximum rated power dissipation can be achieved at half and full rated voltage. Other resistor configurations are also possible by modulating resistor on-states with the available switches.

In DC systems and when using contactors for the switching devices, performance is usually limited by the contactor DC current rating. For cost reasons, an AC contactors are commonly used for switching resistor elements, but with these devices, switching is restricted to low voltages where arcing can be minimized. This limitation prohibits the use of contactor-based switching for dynamic-load applications. In addition, use of DC contactors, while available, are rarely used because of cost and size constraints. Utilizing power semiconductors as the switching elements eliminate the constraint imposed by AC contactors, but are rarely used in favor of MOSFET load technologies.

Most electronic loads using resistive elements are fabricated by end users wanting high-power, low-cost solutions for their testing needs, sacrificing dynamic loading and programmable protection capabilities.

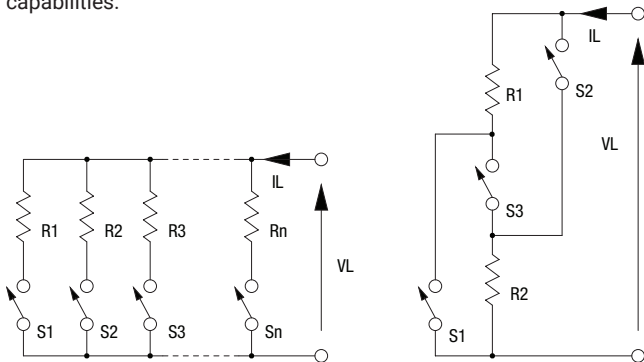

Figure 1. (left) Binary switching and (right) Optimized power switching

MOSFET Loads

Metal Oxide Field Effect Transistors, MOSFETs, loads can be deployed as state-of-the-art electronic loads to address the limitations of resistor-based loads. As illustrated in Figure 2, these electronic loads use semiconductor devices, operated in the linear region, to allow full power and full control over the entire VA rating of the product. MOSFETs have to be specifically rated to operate in the linear region and have safe operating curves well below the maximum power rating when used as an electronic switch.[1-2] Circuitry for MOSFET loads requires each stage to be controlled in a closed loop to linearize the response. As shown in the figure, each device produces a load current defined by V_C/R_n . Closed loop amplifiers enable multiple MOSFETs to share load current equally. In addition, MOSFET loads have a fast dynamic response.

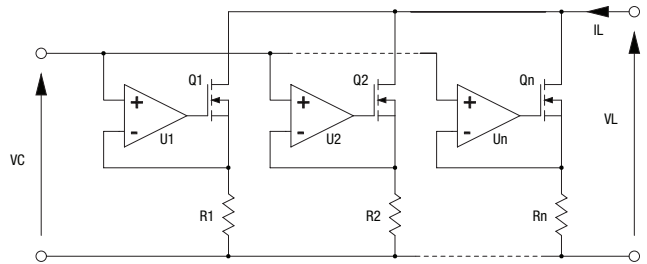

Figure 2. MOSFET Load

The reliability of MOSFET loads depends on the allowed power dissipated per device, current sharing, and cooling design. Water cooling is commonly used to enhance cooling performance and enable higher power loads.

MOSFET loads come at a cost premium over switched resistor loads.

Regenerative Loads

In the past decade, regenerative loads started appearing as a viable product. A regenerative load is, in a simplified sense, an AC to DC power supply with power circuitry reversed to allow current flow in the reverse direction. Response times are similar to that of DC power supplies and special circuitry is needed to stop operation in the event that the power mains voltage is disrupted for any reason. Regenerative loads can be compared to solar inverters as far as performance with exception to the DC range of operation. Like switched resistor loads, obtaining maximum power operation over a wide voltage range requires special circuitry rated at maximum voltage and maximum current; such performance demands can greatly increase the cost as compared to a conventional switching power supply.

The major benefit of regenerative loads is that energy used for testing can be recovered. Some regenerative loads are designed to operate as both a source and sink. These products, regenerative power supplies, must have a dual set of electronic switches.

Using regenerative loads in pulse current applications is not recommended because any pulse current at the input must flow through the unit and appear on the power mains. The economics of regenerative loads must be evaluated in terms of capital equipment costs versus energy savings.

Active Resistive Loads

Active Resistive loads are a blend between switched resistor loads and MOSFET loads. The advantage of resistive loads is cost per watt of dissipating power and the advantage of MOSFET loads is speed of performance and the ability of dissipating power over a wide range of control. Figure 3 shows the basic concept of an Active Resistive load [3]. As illustrated, a critical part of the design is that resistors are placed in series with MOSFETs. MOSFETs are a voltage to current, transconductance, devices. Voltage perturbations resulting from resistors switching are compensated with reverse voltage perturbations across the MOSFETs. Amplifiers, used to share current between devices, do not need to respond

quickly to these voltage changes because of the profile of MOSFET devices when operated as a transconductance device. A constant gate voltage in the device's active region provides nearly a constant current.

The range of maximum power loading, like in resistive loads, depends on the number of resistors, number of switches, and applied voltage. To compromise between the number of dissipative elements and range of maximum power loading, both resistor configurations as described in Figure 1a and 1b, are applied. Careful design of the cooling system can enable maximum power output over half-rated to full-rated voltage. With sufficient number of resistor switching states, power dissipation can be shared with an 80% to 20% ratio for resistor to MOSFET power dissipation, respectively.

Below half-rated voltage and as described previously, maximum power dissipation varies as the square of applied voltage. Having a series MOSFET connection enables a broader profile for lower voltage applications. This requires the resistor elements to be shorted. If the maximum power is limited to 20% of the total using the MOSFET section of the load, this part of the load can provide a 20% maximum power profile. While this is not ideal, it is an effective compromise when considering the cost benefit.

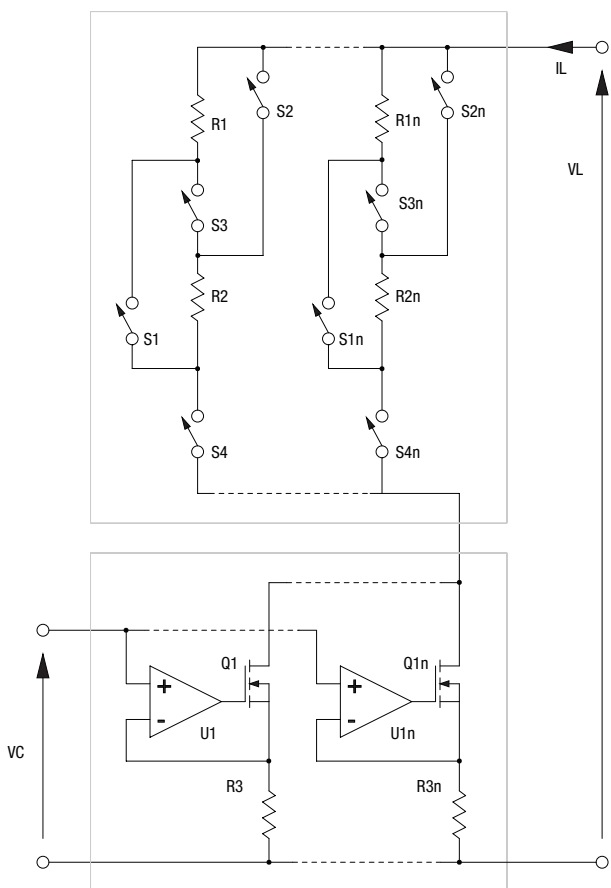

Figure 3. Active Resistance Technology electronic load

With the MOSFET section of the load shorted, the electronic load becomes a purely resistive and the load is operated in rheostat mode. While this could be considered a downgraded load, there are many applications where a purely resistive profile, with no closed loop control, is desirable. The dynamically switched resistor states eliminate the possibility of two closed loops, that of the source and load, to operate against one another. Bandwidth for step changes resistance depends on the speed of the resistor switches. The Active Resistive load can provide 80% of the load's power rating over a range of half-rated to full-rated voltage.

Figure 4 illustrates the load profiles of MOSFET, resistive, and active resistive operation.

Robustness is a key characteristic of Active Resistive loads. Current limiting is constantly enabled with a series connected

resistor. A sudden demand change in current will cause the MOSFETs to saturate protecting the devices from exceeding their safe operating area.

Balancing power between the resistors and MOSFETs presents one of the key challenges for effective Active Resistance load operation. The MOSFETs must have a range of voltage to offset the voltages produced by the switching resistors. Load voltage and current must constantly be monitored to provide resistor state changes along with analog control of the MOSFETs. High speed digital signal processors (DSP's) are required to make such calculations to ensure proper operation. Step load responses require feed forward compensation to force a change in resistance prior to changing load current with the MOSFETs. If step changes in resistance are made quickly and MOSFETs are made to respond soon after, MOSFET safe operating area limitations can be maintained for reliable operation.

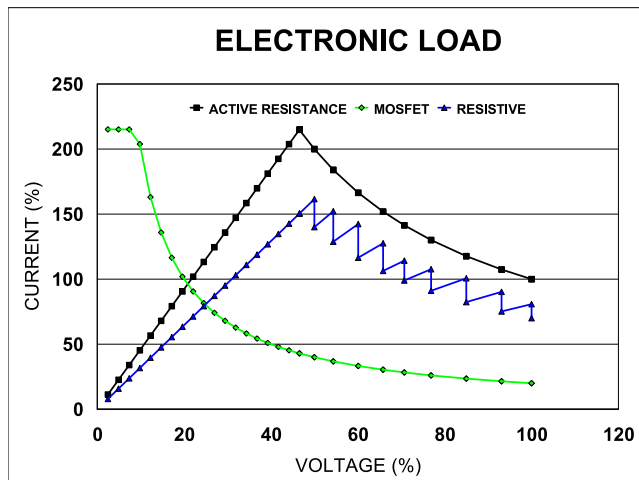

Figure 4. Active Resistance current voltage (IV) load profiles

Conclusion

This article provides an overview of electronic loads currently available, namely: switched resistance, MOSFET, regenerative, and newly introduced hybrid, Active Resistance. Each load topology has advantages and disadvantages, ranging from cost, speed of operation, to loading as a function of applied voltage. The Active Resistance topology has characteristics of switched resistance and MOSFET loads combined as well as operating independently of others.

References

- [1] Sattar and V. Tsukanov, "MOSFETs Withstand Stress of Linear-Mode Operation," Power Electronics Technology, 2007, pp. 34-39.
- [2] J. Dodge, "How to Make Linear Mode Work," Bodo's Power Systems, December 2007.
- [3] I. Pitel, G. Pitel, and A. Pitel, "Electronic Loads," U.S. Patent No. 9,429,629.

Where to Buy

Magna-Power Electronics Partners and Sales Offices

North America

Headquarters, Manufacturing

Magna-Power Electronics, Inc.
39 Royal Road
Flemington, NJ 08822
United States of America

Phone: 1-908-237-2200
Email: sales@magna-power.com
magna-power.com

United Kingdom

Sales Office

Magna-Power Electronics Limited
400 Thames Valley Park Drive
Reading, Berkshire RG6 1PT
United Kingdom

Phone: +44 1189 663143
Email: sales.uk@magna-power.com
magna-power.com

China

Sales Office

Magna-Power Electronics Co., Ltd.
6F, 56 East 4th Ring Road Middle
Beijing, 100025
China

Phone: +86 139 1068 4490
Email: sales.zh@magna-power.com
magna-power.com/zh

Distributors of Magna-Power Electronics products are located worldwide.

To find the nearest sales partner, please visit:
magna-power.com/contact

The logo for Cal Power, featuring the word "Cal" in a bold, black, sans-serif font and "Power" in a bold, red, sans-serif font, both set against a white background with a black underline.

Via Acquarana, 29 22100 COMO
tel. 031.526.566 (r.a.) fax 031.507.984
info@calpower.it www.calpower.it

Magna-Power Electronics – designing and delivering rugged programmable power products, built in the USA to the highest quality standards through a vertically integrated manufacturing process.

Published by
Magna-Power Electronics, Inc.
Flemington, NJ 08822 USA

© 2020 Magna-Power Electronics, Inc.
All Rights Reserved.

Visit us:
magna-power.com

ATTENTION

The information and specifications given in this document are subject to change without notice.

INFORMATION

For further information on technology, terms and conditions, and product prices, contact the nearest Magna-Power Electronics sales partner (magna-power.com/contact).