

Cal Power

Via Acquanera, 29 22100 COMO
tel. 031.526.566 (r.a.) fax 031.507.984
info@calpower.it www.calspower.it

MAGNADC

Programmable DC Power Supplies: 1.5 kW to 2000 kW+

Product Catalog 4.5.0



Innovation in Programmable Power

Magna-Power designs and manufactures robust programmable power products in the USA that set industry standards for quality, size, and control. The company's experience in power electronics is reflected in its 1.25 kW to 2000 kW+ product line, quality service, and reputation for excellence. Today, you will find Magna-Power's standard products at its thousands of customers worldwide, aiding in the manufacture of electric vehicles, simulating solar arrays for development of inverters, steering magnets for particle accelerators, powering radar systems, driving traction controllers for locomotive development, or at a wide range of Universities for cutting-edge energy research.

Quick Facts

Year Founded

1981

Total Power Shipped

390+ megawatts

Headquarters and Manufacturing Location

Flemington, New Jersey USA

Facility Size

73,500 ft²

Vertically Integrated USA Manufacturing

Magna-Power Electronics products are proudly made in the USA at the company's vertically integrated, company designed and owned 73,500 ft² headquarters in Flemington, New Jersey. All engineering, manufacturing and North America product servicing is performed at the company's headquarters.

Magna-Power Electronics utilizes vertical integration in its manufacturing process for complete control over quality, cost, and lead-time of its made-to-order products. As the company has grown, more operations have been internalized.

Vertical integration enables Magna-Power to manufacture a very broad line of sophisticated electronic products, while still maintaining industry leading lead-times. Housing engineering and manufacturing teams in the same facility forces strong collaboration between the two teams for continual process and product improvements.

Internal Company Processes

- Research and development
- Magnetics winding
- Magnetic core punching and cutting
- Full sheet metal operations
- EDM and CNC machining
- Cable harnessing
- Powder coating
- Robotic air- and water-cooled heat-sink fabrication
- Surface-mount and through-hole printed circuit board assembly
- Final assembly, testing, and burn-in

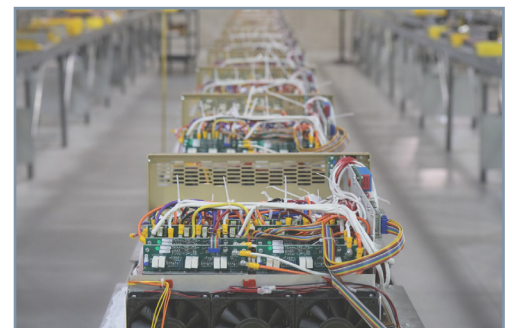
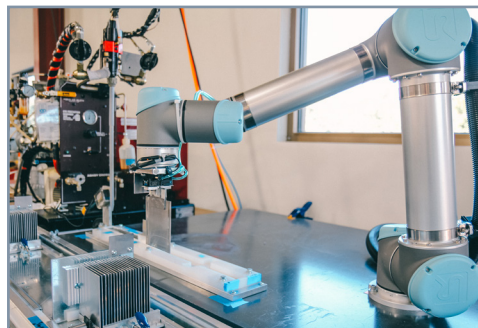
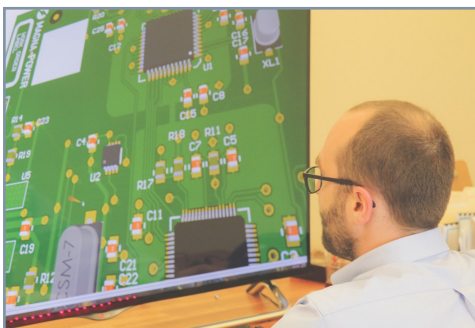



Introduction to MagnaDC 4

An overview of the MagnaDC programmable DC power supply features, functions and front panel

SL Series 6

1.5 kW, 2.6 kW, 4 kW, 6 kW, 8 kW, 10 kW
1U • 127 models • Models up to 1,500 Vdc

XR Series 10

2 kW, 4 kW, 6 kW, 8 kW, 10 kW
2U • 136 models • Models up to 10,000 Vdc

TS Series 14

5 kW, 10 kW, 15 kW, 20 kW, 25 kW, 30 kW, 40 kW, 50 kW, 75 kW, 100 kW
3U to 16U • 275 models • Models up to 6,000 Vdc

MS Series 26

30 kW, 45 kW, 60 kW, 75 kW
Floor-standing • 114 models • Models up to 6,000 Vdc

MT Series 30

100 kW, 150 kW, 250 kW, up to 3000 kW+
Floor-standing • 78 models • Models up to 6,000 Vdc

Integrated Options 36

Built-in options integrated into the MagnaDC programmable DC power supply at time of manufacture

- Blocking Diode (+BD) 36**
- High Isolation (+ISO) 36**
- High Slew Rate Output (+HS) 37**
- IEEE-488 GPIB (+GPIB) 38**
- LXI TCP/IP Ethernet (+LXI) 38**
- Ruggedized (+RUG) 39**
- Water Cooling (+WC) 39**

Accessories 40

External add-ons for MagnaDC programmable DC power supplies

- Cabinets 40**
- DC Power Cables 41**
- RS485 Converter 42**
- Universal Interface Device (UID) 42**
- USB Converter 42**
- DBx Module High-performance add-on module 43**
- BDx Module 1U blocking diode module 45**

Solar Array Emulation Software 46

Software and functionality add-on for MagnaDC programmable DC power supplies to emulate solar arrays

Current-Fed Power Processing 48

A technical paper about Magna-Power's signature current-fed power processing topology

MagnaDC Overview

Fully Programmable DC Power

MagnaDC programmable DC power supplies features programmable voltage, current, and protection settings along with high accuracy measurements. The SL Series functions and features are accessible and configurable from a variety of control methods, including:

- Front panel interface with stepless knobs
- 37-pin isolated analog-digital user I/O
- RS232 Computer interface with software and drivers

Various additional programming interfaces are available, such as LXI TCP/IP Ethernet (+LXI), IEEE-488 GPIB (+GPIB), Edgeport USB Accessory (+USB), RS485 Accessory (+RS485).

Current-Fed Topology: Robust Power Conversion

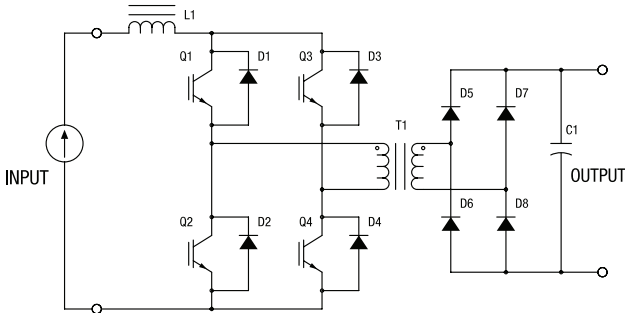

All MagnaDC programmable DC power supplies utilize high-frequency IGBT-based power processing in current-fed topology. This topology adds an additional stage over the conventional voltage-fed topology for enhanced control and system protection, ensuring that even under a fault condition, the power supply will self-protect. Due to the self-protecting characteristics of this topology, the possibility of fast rising current spikes and magnetic core saturation is eliminated.

In addition to its robust topology, key performance characteristics of MagnaDC programmable DC power supplies include:

- High-accuracy voltage and current programming accuracy
- Class-leading line and load regulation performance
- High 3 Φ AC input power factor with in-rush limiting circuitry
- Computer and user I/O isolated from the power supply output

All Magna-Power Electronics power supplies contain circuitry to work harmoniously with other power equipment. Step-start contactors are used to keep inrush current below full scale operating current. Filter components lower current harmonic content emanating from the power supply and increase power factor to levels beyond 90%. Every power supply is tested at 90% to 125% nominal line to ensure satisfactory operation even under the worst line voltage conditions.

Designed for Safety

MagnaDC programmable DC power supplies have extensive diagnostic functions, including:

- AC Phase Loss
- Excessive Thermal Conditions
- Over Voltage Trip (Programmable)
- Over Current Trip (Programmable)
- Cleared Fuse
- Excessive Program Line Voltage
- Interlock Fault

When in standby or diagnostic fault, the AC mains are mechanically disconnected by an embedded AC contactor, providing confidence that the unit is only processing power when desired.

Finally, with a dedicated +5V interlock input pin and included +5V reference on all models, external emergency stop systems can be easily integrated using an external contact.

Included Software Interface: RIS Panel

The Remote Interface Software ships with all power supplies. The software provides the user with an easy and intuitive method to operate a Magna-Power Electronics power supply with computer control. The Remote Interface Software has six windows: Virtual Control Panel, Command Panel, Register Panel, Calibration Panel, Firmware Panel, and Modulation Panel.

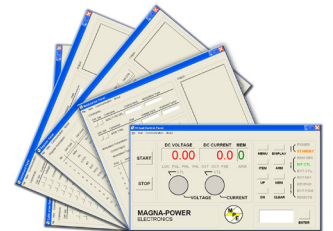

High-Performance Plug and Play Master-Slaving

The MagnaDC programmable DC power supplies' master-slaving strategy helps to ensure no degradation in performance as units are added in parallel or series by providing gate drive signals directly to the slave units from the master. This strategy eliminates the noise susceptibility commonly found when sending analog control references over long distances, in addition to maintaining a single control loop.

The UID47 eases master-slave parallel or series configuration of Magna-Power DC power supplies, enabling near equal current or voltage sharing, depending on the configuration.



Isolated External I/O For Hardware-in-the-Loop or PLC Control

Using the rear isolated 37-pin I/O connector, the MagnaDC programmable power supplies can be completely controlled and monitored using external signals. The voltage, current, over voltage and over current set points are set by applying a 0-10V analog signal. Each diagnostic condition is given a designated pin, which reads +5V when high. Reference +5V and +10V signals are provided, eliminating the need for external voltage signals and allowing the use of dry contacts.

Also, the power supply features a normally closed external interlock, which when enabled, allows the power supply to be tied in with other emergency stop equipment. All these pins are isolated from the output terminals and referenced to earth-ground as standard—no additional isolation equipment or options necessary.

The following list summarizes the available I/O from the power supply:

- 4 analog inputs
- 2 analog outputs
- 5 digital inputs
- 15 digital outputs
- +2.5V, +5V and +10V reference signals

With the High Slew Rate Output (+HS) option equipped, high bandwidth operation is enabled along with fast rise times, allowing the MagnaDC programmable DC power supplies to address requirements for Hardware-in-the-Loop (HIL).

Extensive Programming Support

All MagnaDC programmable DC power supplies come with a dedicated National Instruments LabVIEW™ driver, Interchangeable Virtual Instrument (IVI) driver, and support for a wide range of Standard Commands for Programmable Instrumentation (SCPI). These programming interfaces support full control, measurement, and monitoring of the MagnaDC power supply. All of the MagnaDC power supplies are available communication interfaces are supported by these drivers and command sets, including: RS232, LXI TCP/IP Ethernet, IEEE-488 GPIB, USB or RS485.

Showcased in the following basic code examples, SCPI commands provide the simplest form of communication by using plain ASCII text and parameters sent over a basic socket connection. Over 50 commands are provided, with detailed documentation in the SL Series User Manual.

Python programming example using SCPI commands

```
import serial
conn = serial.Serial(port='COM8', baudrate=19200)
conn.write('*IDN?\n')
print conn.readline()
conn.write('VOLT 1000\n')
conn.write('CURR 5\n')
conn.write('OUTP:START\n')
conn.write('MEAS:CURR?\n')
print conn.readline()
```

Designed and Manufactured in the USA



For complete control of quality, MagnaDC programmable DC power supplies are designed and manufactured at

Magna-Power's vertically integrated USA manufacturing facility in Flemington, New Jersey. Heat-sinks and chassis are machined from aluminum. All sheet metal is fabricated and powder coated in-house. Magnetics are wound-to-order from validated designs based on a model's voltage and current. An automated surface-mount production line places components on printed circuit boards for control, driver, auxiliary power, and display circuits. And finally after assembly, products undergo comprehensive test and NIST-traceable calibration, followed by an extended burn-in period.

Tailor Performance with Integrated Options

Magna-Power's MagnaDC programmable power supplies are designed to be flexible, depending on the application's requirements. With its configured-to-order integrated options, including:

- Blocking Diode (+BD)
- IEEE-488 GPIB (+GPIB)
- High Slew Rate Output (+HS)
- High Isolation Output (+ISO)
- LXI TCP/IP Ethernet (+LXI)
- Ruggedized (+RUG)
- Water Cooling (+WC)



SL Series

1U Programmable DC Power Supply • Rugged Current-Fed Power Processing



Overview

The SL Series builds on nearly 40 years of power supply innovation at Magna-Power, designed from the ground up to meet the highly reliable power dense demands of ATE system integrators through Magna-Power's signature current-fed power processing topology. Utilizing state-of-the-art semiconductors and innovative internally designed and manufactured heat sinks, the SL Series offers industry-leading 1U (1.75" height) programmable power levels with models at 1.5 kW, 2.6 kW, 4 kW, 6 kW, 8 kW, and 10 kW, while still maintaining an ambient operating temperature rating up to 50°C.

Models

	1.5 kW	2.6 kW	4 kW	6 kW	8 kW	10 kW		
Max Voltage (Vdc)	Max Current (Aac)						Ripple ¹ (mVrms)	Efficiency
5	250	N/A	N/A	N/A	N/A	N/A	50	84%
10	150	250	N/A	N/A	N/A	N/A	40	89%
16	93	162	250	N/A	N/A	N/A	35	89%
20	75	130	200	250	N/A	N/A	40	90%
25	60	104	160	240	N/A	N/A	40	91%
32	46	81	125	186	250	N/A	40	91%
40	37	65	100	150	200	250	40	91%
50	30	52	80	120	160	200	50	92%
60	25	43	66	100	133	166	60	93%
80	18	32	50	75	100	125	60	93%
100	15	26	40	60	80	100	60	93%
125	12	20	32	48	64	80	100	93%
160	9	16	25	36	50	60	120	93%
200	7.5	13	20	30	40	50	125	94%
250	6	10.4	16	24	32	40	130	94%
300	5	8.6	13.2	20	26.4	33.3	160	94%
375	4	6.9	10.4	16	21.3	26.5	170	94%
400	3.7	6.5	10	15	20	25	180	95%
500	3	5.2	8	12	16	20	220	95%
600	2.5	4.3	6.4	10	13.3	16.5	250	95%
800	1.8	3.2	5	7.5	10	12.5	300	95%
1000	1.5	2.6	4	6	8	10	350	95%
1250	1.2	2	3.2	4.8	6.4	8	375	95%
1500	1	1.7	2.6	4	5.3	6.6	400	95%
AC Input Voltage (Vac)	Input Current Per Phase (Aac)							
UI (85-265 Vac, 1Φ)	21-7	N/A	N/A	N/A	N/A	N/A		
UI2 (187-265 Vac, 1Φ)	N/A	16-12	N/A	N/A	N/A	N/A		
208/240 Vac, 3Φ	6	11	16	24	32	39		
380/415 Vac, 3Φ	5	8	11	16	19	22		
440/480 Vac, 3Φ	4	6	9	14	17	19		

Key Features

- SCPI Remote Programming API
- High Accuracy Measurements
- Master-Slave Functionality
- Remote Sensing
- 37-Pin External User I/O
- RS232 Interface
- Ethernet and GPIB Available
- 0-10V External Analog Inputs
- Programmable Protection Limits
- Fast Transient Response
- Remote Interface Software
- NI LabVIEW™ and IVI Driver
- Interlock Shutdown Input
- Designed and Manufactured in the USA

Available Options

- High Slew Rate Output (+HS)
- IEEE-488 GPIB Communications (+GPIB)
- LXI TCP/IP Ethernet Communications (+LXI)
- Ruggedized (+RUG)

SL Series Model Ordering Guide

There are 127 different models in the SL Series spanning power levels: 1.5 kW, 2.6 kW, 4 kW, 6 kW, 8 kW, 10 kW.

To determine the appropriate model:

1. Select the desired Max Voltage (Vdc) from the left-most column.
2. Select the desired Max Current (Aac) from the same row that contains your desired Max Voltage.
3. Construct your model number according to the model ordering guide.

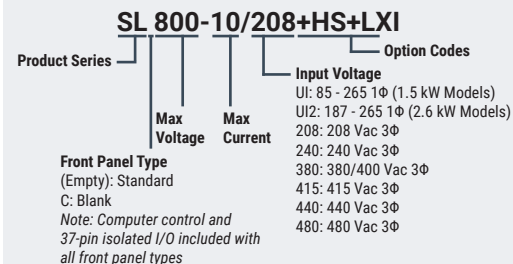

¹ Ripple specified for standard models. Ripple will be higher for models with the High Slew Rate Output (+HS). Refer to option page for more details.

Specifications

AC Input Specifications

1Φ AC Input Voltage 1 Φ , 2-wire + ground	85 to 265 Vac (UI: Universal input; 1.5 kW Models) 187 to 265 Vac (UI2: Universal input; 2.6 kW Models)
3Φ AC Input Voltage 3 Φ , 3-wire + ground Available on all models	208 Vac (operating range 187 to 229 Vac) 240 Vac (operating range 216 to 264 Vac) 380/400 Vac (operating range 342 to 440 Vac) 415 Vac (operating range 373 to 456 Vac) 440 Vac (operating range 396 to 484 Vac) 480 Vac (operating range 432 to 528 Vac)
AC Input Current	Refer to chart of available models
AC Input Frequency	50-400 Hz
Power Factor	0.99 at max power; models with 1 Φ AC input >0.82 at max power; models with 3 Φ AC input
AC Input Isolation	\pm 2500 Vac, maximum input voltage to ground

Output Specifications

Voltage Ripple	Refer to chart of available models.
Line Regulation	Voltage mode: \pm 0.004% of full scale Current mode: \pm 0.02% of full scale
Load Regulation	Voltage mode: \pm 0.01% of full scale Current mode: \pm 0.04% of full scale
Load Transient Response	2 ms to recover within \pm 1% of regulated output with a 50% to 100% or 100% to 50% step load change
Stability	\pm 0.10% for 8 hrs. after 30 min. warm-up
Efficiency	84% to 95%; refer to chart of available models
DC Output Isolation Models Rated \leq 1000 Vdc	\pm 1000 Vdc, max output voltage to ground
DC Output Isolation Models Rated >1000 Vdc	\pm 1500 Vdc, max output voltage to ground

Programming Specifications

Programming Accuracy	Voltage: \pm 0.075% of max voltage rating Current: \pm 0.075% of max current rating
Measurement Accuracy	Voltage: \pm 0.2% of max voltage rating Current: \pm 0.2% of max current rating
Maximum Slew Rate Standard Models	100 ms, output voltage change from 0 to 63% 100 ms, output current change from 0 to 63%
Maximum Slew Rate Models with High Slew Rate Option (+HS)	4 ms, output voltage change from 0 to 63% 8 ms, output current change from 0 to 63%
Trip Settings Range	Over Voltage: 10% to 110% max voltage rating Over Current: 10% to 110% max current rating
Computer Command Protocol	Standard Commands for Programmable Instruments (SCPI)
Remote Sense Limits Wired; Available on Models Rated \leq 1000 Vdc	3% maximum voltage drop from output to load

Connectivity Specifications

Communication Interfaces (Standard)	RS232: DB-9, Female External User I/O: DB-37, Female
Communication Interfaces (Optional)	LXI TCP/IP Ethernet: RJ-45 GPIB: IEEE-488

External User I/O Specifications

Digital Inputs	5 V, 10 k Ω impedance
Digital Monitoring Signals	5 V, 5 mA capacity
Digital Reference Signal	5 V output, 25 mA capacity
Analog Programming Input	0-10 V
Analog Programming Impedance	10 k Ω
Analog Monitoring Signals	0-10 V, 5 mA capacity
Analog Monitoring Impedance	100 Ω
Analog Monitoring Accuracy	0.2% of max rating
Analog Reference Signal	10 V, 5 mA capacity, 1 Ω impedance

Physical Specifications

Racking Standard	EIA-310
Rear Support Rails	Included

Power Level	Rack Units	Size	Weight
1.5 kW	1U	1.75" H x 19" W x 24" D (4.4 x 48.3 x 61.0 cm)	32 lbs (14.52 kg)
2.6 kW	1U	1.75" H x 19" W x 24" D (4.4 x 48.3 x 61.0 cm)	34 lbs (15.42 kg)
4 kW	1U	1.75" H x 19" W x 24" D (4.4 x 48.3 x 61.0 cm)	35 lbs (15.88 kg)
6 kW	1U	1.75" H x 19" W x 24" D (4.4 x 48.3 x 61.0 cm)	35 lbs (15.88 kg)
8 kW	1U	1.75" H x 19" W x 24" D (4.4 x 48.3 x 61.0 cm)	36 lbs (16.33 kg)
10 kW	1U	1.75" H x 19" W x 24" D (4.4 x 48.3 x 61.0 cm)	37 lbs (16.78 kg)

Environmental Specifications

Ambient Operating Temperature	-25°C to 50°C
Storage Temperature	-25°C to +85°C
Humidity	Relative humidity up to 95% non-condensing
Air Flow	Side air inlet, rear exhaust
Temperature Coefficient	0.04%/°C of maximum output voltage 0.06%/°C of maximum output current

Regulatory Compliance

EMC	Complies with 2014/30/EU (EMC Directive) CISPR 22 / EN 55022 Class A
Safety	NRTL Listed, Intertek Control Number 5014353 Conforms to UL61010-1:2012 Ed.3+R:29Apr2016 Certified to CSA C22.2#61010-1-12:2012 Ed.3 Complies with EN61010-1 Complies with 2014/35/EU (Low Voltage Directive)
CE Mark	Yes
RoHS Compliant	Yes

Note: Specifications are subject to change without notice. Input voltage specifications are line-to-line.

SL Series

1U Programmable DC Power Supply • Rugged Current-Fed Power Processing

Product Diagrams

Front Panel

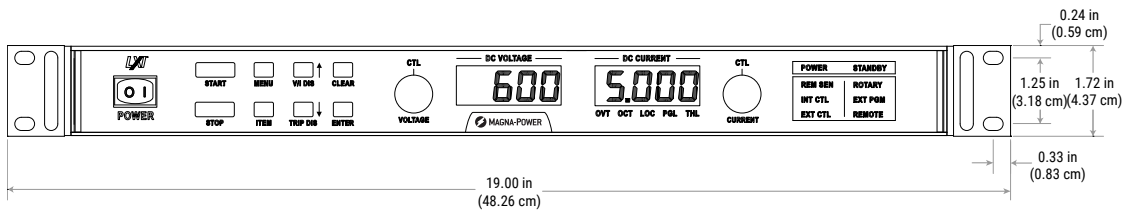

Rear Panel

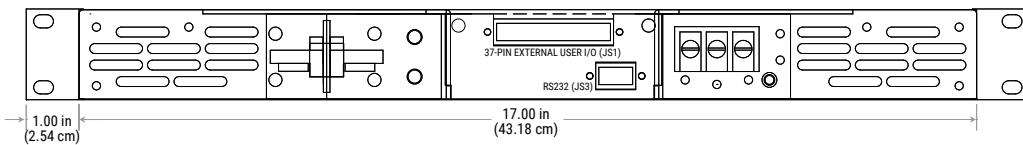

Top Rear View

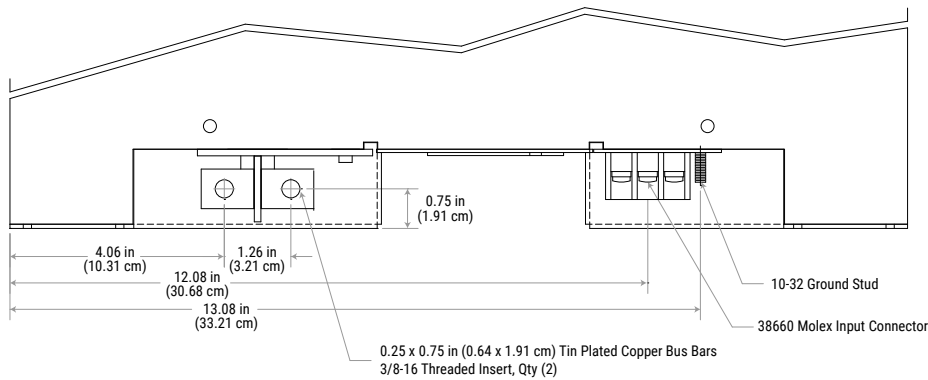

Side Panel

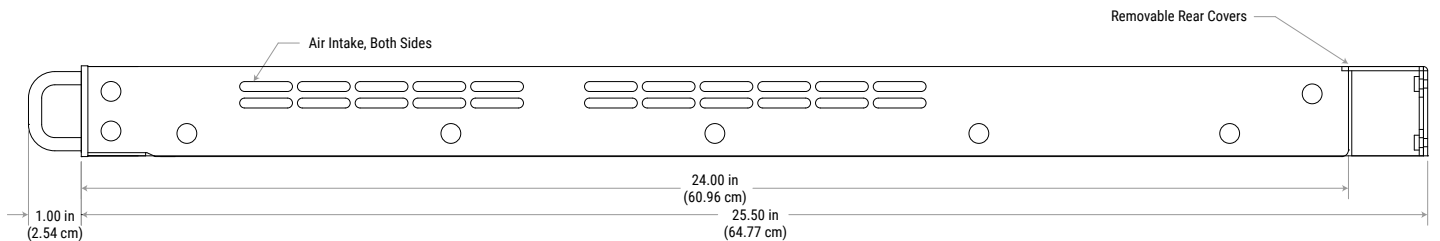

Communications

IEEE-488 GPIB (+GPIB) Option

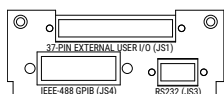

Communications

LXI TCP/IP Ethernet (+LXI) Option

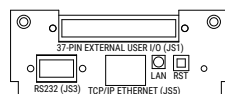

Front Panel Overview

Standard SL Series Front Panel

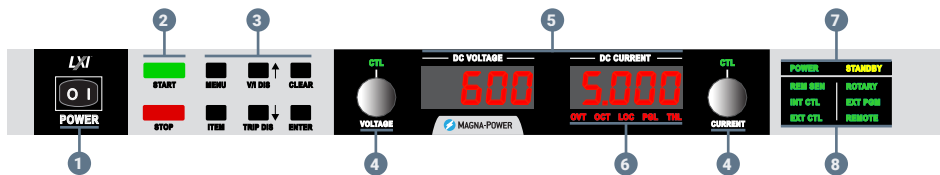

C Version Front Panel - Blank



- 1 Power switch energizes control circuits without engaging main power
- 2 Engages and disengages main power via integrated mechanical contactor
- 3 Function Keys
MENU: Selects function
ITEM: Selects item within function
V/I DIS: Displays voltage and current settings
TRIP DIS: Displays OVT and OCT setting
CLEAR: Clears settings or resets fault
ENTER: Select item
- 4 Stepless rotary knob to set voltage and current
- 5 Meters display output voltage, output current, voltage set point, current set point, over voltage trip and over current trip
- 6 Diagnostic Alarms
LOC: Interlock
PGL: External input voltage beyond limits
THL: Over-temperature condition
OVT: Over-voltage protection has tripped
OCT: Over-current protection has tripped
- 7 POWER: Indicates power output
STANDBY: Indicates control power only
- 8 REM SEN: Remote sense enabled
INT CTL: Front panel start/stop/clear enabled
EXT CTL: External start/stop/clear enabled
ROTARY: Front panel rotary knob input
EXT PGM: External analog voltage-current control
REMOTE: Computer control



XR Series

2U Programmable DC Power Supply • Rugged Current-Fed Power Processing



Overview

The XR Series was designed from the ground up for high reliability and industry leading 2U (3.5" height) rack-mount programmable power levels, at: 2 kW, 4 kW, 6 kW, 8 kW, and 10 kW. The XR Series features the largest voltage range in Magna-Power's product offering, from 5 Vdc to 10,000 Vdc, all utilizing the company's signature current-fed power processing to deliver robust power conversion. In addition, high accuracy programming and monitoring levels allow confidence in power supply measurements, eliminating the need for external power meters.

Models

	2 kW	4 kW	6 kW	8 kW	10 kW		
Max Voltage (Vdc)	Max Current (A _{dc})					Ripple ¹ (mV _{rms})	Efficiency
5	375	600	N/A	N/A	N/A	50	80%
10	200	375	600	N/A	N/A	50	84%
16	125	250	375	500	600	50	84%
20	100	200	300	375	500	45	87%
25	80	160	240	320	400	45	88%
32	62	124	186	250	310	40	88%
40	50	100	150	200	250	40	88%
50	40	80	120	160	200	50	90%
60	33	66	100	133	166	60	91%
80	25	50	75	100	125	60	91%
100	20	40	60	80	100	60	91%
125	16	32	48	64	80	100	91%
160	12	24	36	50	60	120	91%
200	10	20	30	40	50	125	92%
250	8	16	24	32	40	130	92%
300	6.6	13.2	19.8	26.4	33.3	160	92%
375	5.3	10.6	15.9	21.3	26.5	170	92%
400	5	10	15	20	25	180	92%
500	4	8	12	16	20	220	93%
600	3.3	6.6	9.9	13.3	16.5	250	93%
800	2.5	5	7.5	10	12.5	300	93%
1000	2	4	6	8	10	350	93%
1250	1.6	3.2	4.8	6.4	8	375	93%
1500	1.3	2.6	4	5.3	6.6	400	93%
2000	1	2	3	4	5	450	93%
3000	0.6	1.3	2	2.6	3.3	500	93%
4000	0.5	1	1.5	2	N/A	6500	93%
6000	0.33	0.66	1	1.33	N/A	7500	93%
8000	0.25	0.5	0.75	1	N/A	8500	93%
10000	0.2	0.4	0.6	0.8	N/A	9500	93%
AC Input Voltage (Vac)	Input Current Per Phase (A _{ac})						
208/240 Vac, 1Φ	17	N/A	N/A	N/A	N/A		
208/240 Vac, 3Φ	8	15	22	29	35		
380/415 Vac, 3Φ	5	9	12	16	19		
440/480 Vac, 3Φ	4	8	11	14	17		

Key Features

- SCPI Remote Programming API
- High Accuracy Measurements
- Master-Slave Functionality
- Remote Sensing
- 37-Pin External User I/O
- RS232 Interface
- Ethernet and GPIB Available
- 0-10V External Analog Inputs
- Programmable Protection Limits
- Fast Transient Response
- Remote Interface Software
- NI LabVIEW™ and IVI Driver
- Interlock Shutdown Input
- Designed and Manufactured in the USA

Available Options

- High Slew Rate Output (+HS)
- IEEE-488 GPIB Communications (+GPIB)
- LXI TCP/IP Ethernet Communications (+LXI)
- Ruggedized (+RUG)

XR Series Model Ordering Guide

There are 136 different models in the XR Series spanning power levels: 2 kW, 4 kW, 6 kW, 8 kW, 10 kW.

To determine the appropriate model:

1. Select the desired Max Voltage (Vdc) from the left-most column.
2. Select the desired Max Current (A_{dc}) from the same row that contains your desired Max Voltage.
3. Construct your model number according to the model ordering guide.

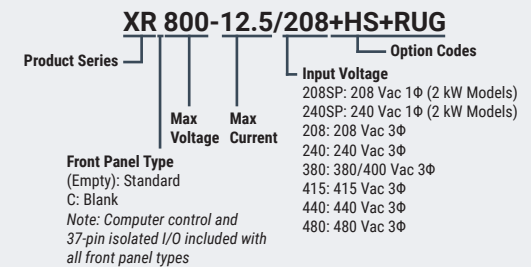

¹ Ripple specified for standard models. Ripple will be higher for models with the High Slew Rate Output (+HS). Refer to option page for more details.

Specifications

AC Input Specifications

1Φ AC Input Voltage 1Φ, 2-wire + ground Available on 2 kW models	208 Vac (208SP; operating range 187 - 229 Vac) 240 Vac (240SP; operating range 216 - 264 Vac)
3Φ AC Input Voltage 3Φ, 3-wire + ground Available on all models	208 Vac (operating range 187 to 229 Vac) 240 Vac (operating range 216 to 264 Vac) 380/400 Vac (operating range 342 to 440 Vac) 415 Vac (operating range 373 to 456 Vac) 440 Vac (operating range 396 to 484 Vac) 480 Vac (operating range 432 to 528 Vac)
AC Input Current	Refer to chart of available models
AC Input Frequency	50-400 Hz
Power Factor	>0.92 at max power; models with 3Φ AC input 0.70 at max power; models with 1Φ AC input
AC Input Isolation	±2500 Vac, maximum input voltage to ground

Output Specifications

Voltage Ripple	Refer to chart of available models.
Line Regulation	Voltage mode: ± 0.004% of full scale Current mode: ± 0.02% of full scale
Load Regulation	Voltage mode: ± 0.01% of full scale Current mode: ± 0.04% of full scale
Load Transient Response	2 ms to recover within ±1% of regulated output with a 50% to 100% or 100% to 50% step load change
Stability	± 0.10% for 8 hrs. after 30 min. warm-up
Efficiency	80% to 93%; refer to chart of available models
DC Output Isolation Models Rated ≤1000 Vdc	±1000 Vdc, max output voltage to ground
DC Output Isolation Models Rated >1000 Vdc and ≤3000 Vdc	±(1500 Vdc + Vo/2), max output voltage to ground, where Vo is the max rated voltage
DC Output Isolation Models Rated >3000 Vdc	No output isolation, specify positive or negative output polarity at time of order

Programming Specifications

Programming Accuracy	Voltage: ±0.075% of max voltage rating Current: ±0.075% of max current rating
Measurement Accuracy	Voltage: ±0.2% of max voltage rating Current: ±0.2% of max current rating
Maximum Slew Rate Standard Models	100 ms, output voltage change from 0 to 63% 100 ms, output current change from 0 to 63%
Maximum Slew Rate Models with High Slew Rate Option (+HS) and Models Rated >3000 Vdc >3000 Vdc	4 ms, output voltage change from 0 to 63% 8 ms, output current change from 0 to 63%
Trip Settings Range	Over Voltage: 10% to 110% max voltage rating Over Current: 10% to 110% max current rating
Computer Command Protocol	Standard Commands for Programmable Instruments (SCPI)
Remote Sense Limits Wired; Available on Models Rated ≤1000 Vdc	3% maximum voltage drop from output to load

External User I/O Specifications

Digital Inputs	5 V, 10 kΩ impedance
Digital Monitoring Signals	5 V, 5 mA capacity
Digital Reference Signal	5 V output, 25 mA capacity
Analog Programming Input	0-10 V
Analog Programming Impedance	10 kΩ
Analog Monitoring Signals	0-10 V, 5 mA capacity
Analog Monitoring Impedance	100 Ω
Analog Monitoring Accuracy	0.2% of max rating
Analog Reference Signal	10 V, 5 mA capacity, 1 Ω impedance

Physical Specifications

Racking Standard	EIA-310
Rear Support Rails	Included

Power Level	Rack Units	Size	Weight
2 kW	2U	3.50" H x 19" W x 24" D (8.89 x 48.26 x 60.96 cm)	45 lbs (20.41 kg)
4 kW	2U	3.50" H x 19" W x 24" D (8.89 x 48.26 x 60.96 cm)	47 lbs (21.32 kg)
6 kW	2U	3.50" H x 19" W x 24" D (8.89 x 48.26 x 60.96 cm)	48 lbs (21.77 kg)
8 kW	2U	3.50" H x 19" W x 24" D (8.89 x 48.26 x 60.96 cm)	48 lbs (21.77 kg)
10 kW	2U	3.50" H x 19" W x 24" D (8.89 x 48.26 x 60.96 cm)	48 lbs (21.77 kg)

Environmental Specifications

Ambient Operating Temperature	0°C to 50°C
Storage Temperature	-25°C to +85°C
Humidity	Relative humidity up to 95% non-condensing
Air Flow	Side air inlet, rear exhaust
Temperature Coefficient	0.04%/°C of maximum output voltage 0.06%/°C of maximum output current

Regulatory Compliance

EMC	Complies with European EMC Directive for test and measurement products, 2014/30/EU
Safety	Complies with EN61010-1:2010
CE Mark	Yes
RoHS Compliant	Yes

Connectivity Specifications

Communication Interfaces (Standard)	RS232: DB-9, Female External User I/O: DB-37, Female
Communication Interfaces (Optional)	LXI TCP/IP Ethernet: RJ-45 GPIB: IEEE-488

Note: Specifications are subject to change without notice. Input voltage specifications are line-to-line.

XR Series

2U Programmable DC Power Supply • Rugged Current-Fed Power Processing

Product Diagrams

Front Panel

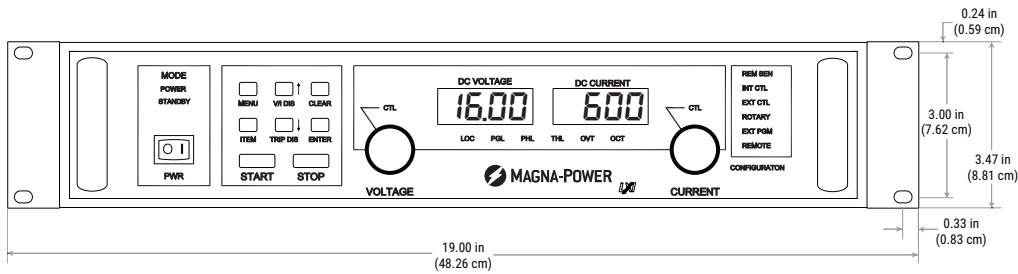

Rear Panel

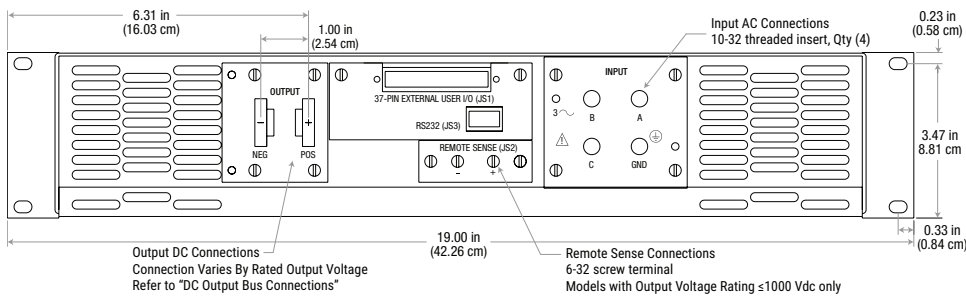

Side Panel

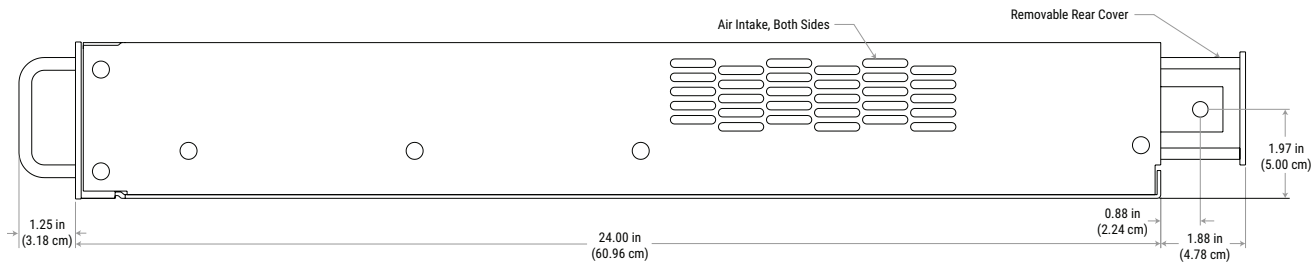

DC Output Bus

Models Rated 1000 Vdc and Below

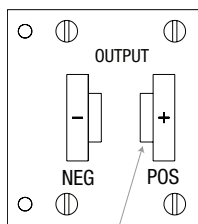

0.250 x 1.000 Tin Plated Copper Bus
3/8-16 Threaded Insert, Qty (2)

DC Output Bus

Models Rated Above 1000 Vdc to 3000 Vdc

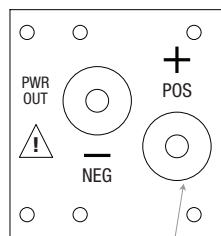

1/4-20 Bolt, Qty (2)

DC Output Bus

Models Rated Above 3000 Vdc

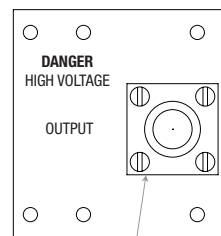

83-1R Receptacle
High Voltage Mating Cable Provided

Communications

IEEE-488 GPIB (+GPIB) Option

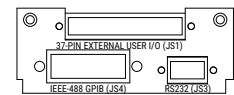

Communications

LXI TCP/IP Ethernet (+LXI) Option

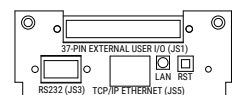

High Voltage Output Cable

Included with Models Rated Above 3000 Vdc



Front Panel Overview

Standard XR Series Front Panel

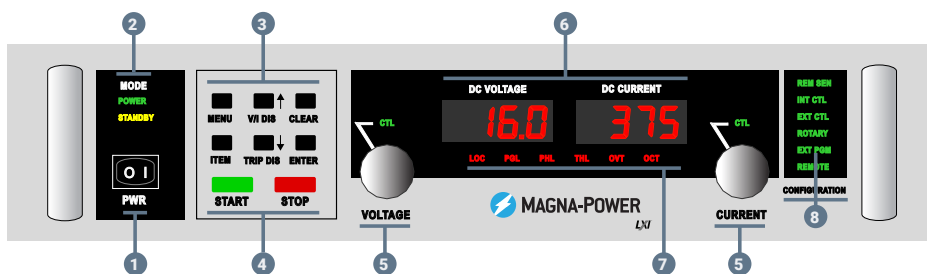

C Version Front Panel - Blank



- 1 Power switch energizes control circuits without engaging main power
- 2 POWER: Indicates power output
STANDBY: Indicates control power only
- 3 Function Keys
MENU: Selects function
ITEM: Selects item within function
V/I DIS: Displays voltage and current settings
TRIP DIS: Displays OVT and OCT setting
CLEAR: Clears settings or resets fault
ENTER: Select item
- 4 Engages and disengages main power via integrated mechanical contactor
- 5 Stepless rotary knob to set voltage and current
- 6 Meters display output voltage, output current, voltage set point, current set point, over voltage trip and over current trip
- 7 Diagnostic Alarms
LOC: Interlock
PGL: External input voltage beyond limits
THL: Over-temperature condition
OVT: Over-voltage protection has tripped
OCT: Over-current protection has tripped
- 8 REM SEN: Remote sense enabled
INT CTL: Front panel start/stop/clear enabled
EXT CTL: External start/stop/clear enabled
ROTARY: Front panel rotary knob input
EXT PGM: External analog voltage-current control
REMOTE: Computer control



(15) XR Series Power Supplies with +CAB3 Option

TS Series

3U to 16U Programmable DC Power Supply • Rugged Current-Fed Power Processing

Overview

The TS Series offers many models spanning a wide voltage and current range, while still maintaining among the highest power density rack-mount packaging. The TS Series covers voltages from 5 Vdc up to 6000 Vdc (floating) and current levels from 1.2 Adc up to 8000 Adc. Models 5 kW to 15 kW are available in a 3U chassis, models 20 kW and 25 kW are available in a 4U chassis, models 30 kW are available in a 6U chassis, models 40 kW and 50 kW are available in an 8U chassis with removable casters, models 75 kW models are available in a 12U chassis with removable casters, and 100 kW models are available in a 16U chassis with removable casters. In addition, there are several special low voltage high current models, enabling a more cost-effective solution for these requirements. All TS Series power supplies come standard with isolated 37-pin external I/O, RS232, Remote Interface Software, IVI drivers, and LabVIEW drivers for integration into a variety of programming environment.



TS Series 4U Models. Rack-mount kit included.

Models

	5 kW	10 kW	15 kW	20 kW	25 kW	30 kW	40 kW	50 kW	75 kW	100 kW		
	3U	3U	3U	4U/6U ³	4U/6U ³	6U	8U	8U	12U	16U		
Max Voltage (Vdc)	Max Current (Adc)										Ripple ¹ (mVrms)	Efficiency
5	900	1800 ²	2700 ²	N/A	N/A	N/A	N/A	N/A	N/A	N/A	50	84%
8	600	N/A	N/A	N/A	N/A	N/A	N/A	N/A	N/A	N/A	40	85%
10	500	900	N/A	2000 ⁴	2700 ²	N/A	4000	N/A	6000	8000	40	87%
16	300	600	900	N/A	N/A	1800	N/A	N/A	N/A	N/A	35	87%
20	250	500	750	1000	1250	1500	2000	2500	3750	5000	40	88%
25	200	400	600	800	1000	1200	1600	2000	3000	4000	40	89%
32	150	300	450	625	781	900	1250	1562	2343	3124	40	89%
40	125	250	375	500	625	750	1000	1250	1875	2500	40	89%
50	100	200	300	400	500	600	800	1000	1500	2000	50	89%
60	83	166	249	333	416	498	666	832	1248	1664	60	90%
80	62	124	186	250	312.5	372	500	625	937.5	1250	60	90%
100	50	100	150	200	250	300	400	500	750	1000	60	90%
125	40	80	120	160	200	240	320	400	600	800	100	90%
160	31	62	93	125	156	186	250	312	468	624	120	90%
200	25	50	75	100	125	150	200	250	375	500	125	91%
250	20	40	60	80	100	120	160	200	300	400	130	91%
300	16	32	48	66.6	83.3	96	133.2	166.6	249.9	333.2	160	91%
375	13	26	39	53.3	66.6	78	106.6	133.2	199.8	266.4	170	92%
400	12	24	36	50	62.4	72	100	125	187.2	249.6	180	92%
500	10	20	30	40	50	60	80	100	150	200	220	92%
600	8	16	24	33.3	41.6	48	66.6	83.2	124.8	166.4	250	92%
800	6	12	18	25	31.2	36	50	62.4	93.6	124.8	300	92%
1000	5	10	15	20	25	30	40	50	75	100	350	92%
1250	4	8	12	16	20	24	32	40	60	80	375	92%
1500	3.3	6.6	9.9	13.3	16.6	19.8	26.6	33.2	49.8	66.4	400	92%
2000	2.5	5	7.5	10	12.5	15	20	25	37.5	50	600	92%
3000	1.6	3.2	4.8	6.6	8.3	9.6	13.2	16.6	24.9	33.2	650	92%
4000	1.2	2.4	3.6	5	6.2	7.2	10	12.4	18.6	24.8	700	92%
5000	1	2	3	4	5	6	8	10	15	20	1500	92%
6000	0.8	1.6	2.5	3.3	4.1	5	6.6	8.3	12.3	16.4	1700	92%
AC Input Voltage (Vac)	Input Current Per Phase (Aac)											
208/240 Vac, 1Φ	41	N/A	N/A	N/A	N/A	N/A	N/A	N/A	N/A	N/A		
208/240 Vac, 3Φ	18	36	52	69	85	105	N/A	N/A	N/A	N/A		
380/415 Vac, 3Φ	10	20	29	38	47	57	76	94	141	188		
440/480 Vac, 3Φ	9	17	25	33	40	50	66	82	120	160		

¹ Ripple specified for standard models. Ripple will be higher for models with the High Slew Rate Output (+HS). Refer to option page for more details.

² Low voltage, high current models have a size size and input current rating that differ from the rated specifications for models within the same power level. Contact your Magna-Power sales partner for more details.

³ 20/25 kW models with 380/415, 3Φ input or 440/480 Vac, 3Φ input come in a 4U chassis. 20/25 kW models with 208/240, 3Φ input come in a 6U chassis.

⁴ Available only with 380/415, 3Φ input or 440/480 Vac, 3Φ input

TS Series

3U to 16U Programmable DC Power Supply • Rugged Current-Fed Power Processing

Key Features

- SCPI Remote Programming API
- High Accuracy Measurements
- Master-Slave Functionality
- Remote Sensing
- 37-Pin External User I/O
- RS232 Interface
- Ethernet and GPIB Available
- 0-10V External Analog Inputs
- Programmable Protection Limits
- Fast Transient Response
- Remote Interface Software
- NI LabVIEW™ and IVI Driver
- Interlock Shutdown Input
- Designed and manufactured in the USA

Available Options

- Blocking Diode (+BD)
- High Isolation Output (+ISO)
- High Slew Rate Output (+HS)
- IEEE-488 GPIB Communications (+GPIB)
- LXI TCP/IP Ethernet Communications (+LXI)
- Water Cooling (+WC)

TS Series Model Ordering Guide

There are 275 different models in the TS Series spanning power levels: 5 kW, 10 kW, 15 kW, 20 kW, 25 kW, 30 kW, 40 kW, 50 kW, 75 kW and 100 kW.

To determine the appropriate model:

1. Select the desired Max Voltage (Vdc) from the left-most column.
2. Select the desired Max Current (A_{dc}) from the same row that contains your desired Max Voltage.
3. Construct your model number according to the model ordering guide.

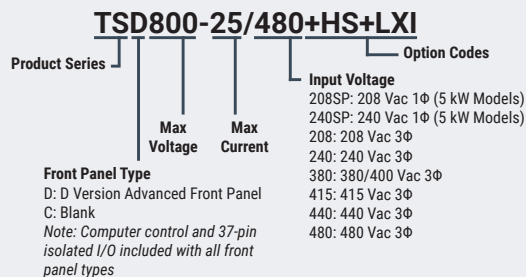

Specifications

Physical Specifications

Power Level	Rack Units	Size	Weight
5 kW	3U	5.25" H x 19" W x 24" D (13.34 x 48.26 x 60.96 cm)	74 lbs (34.57 kg)
10 kW	3U	5.25" H x 19" W x 24" D (13.34 x 48.26 x 60.96 cm)	94 lbs (42.64 kg)
15 kW	3U	5.25" H x 19" W x 24" D (13.34 x 48.26 x 60.96 cm)	125 lbs (56.70 kg)
20 kW 380/415 Vac, 3Φ input 440/480 Vac, 3Φ input	4U	7" H x 19" W x 24" D (17.8 x 48.2 x 60.9 cm)	160 lbs (72.6 kg)
20 kW 208/240 Vac, 3Φ input	6U	10.5" H x 19" W x 24" D (26.67 x 48.26 x 60.96 cm)	185 lbs (83.9 kg)
25 kW 380/415 Vac, 3Φ input 440/480 Vac, 3Φ input	4U	7" H x 19" W x 24" D (17.8 x 48.2 x 60.9 cm)	180 lbs (81.7 kg)
25 kW 208/240 Vac, 3Φ input	6U	10.5" H x 19" W x 24" D (26.67 x 48.26 x 60.96 cm)	220 lbs (99.79 kg)
25 kW	4U	7" H x 19" W x 24" D (17.8 x 48.2 x 60.9 cm)	185 lbs (83.9 kg)
30 kW	6U	10.5" H x 19" W x 24" D (26.67 x 48.26 x 60.96 cm)	245 lbs (111.1 kg)
40 kW	8U	With casters removed: 14" H x 19" W x 24" D (35.6 x 48.2 x 60.9 cm) With casters attached: 17.75" H x 19" W x 24" D (45.1 x 48.2 x 60.9 cm)	315 lbs (142.9 kg)
50 kW	8U	With casters removed: 14" H x 19" W x 24" D (35.6 x 48.2 x 60.9 cm) With casters attached: 17.75" H x 19" W x 24" D (45.1 x 48.2 x 60.9 cm)	355 lbs (161.0 kg)
75 kW	12U	With casters removed: 21" H x 19" W x 24" D (53.3 x 48.2 x 60.9 cm) With casters attached: 24.75" H x 19" W x 24" D (62.9 x 48.2 x 60.9 cm)	540 lbs (244.9 kg)
100 kW	16U	With casters removed: 28" H x 19" W x 24" D (71.1 x 48.2 x 60.9 cm) With casters attached: 31.75" H x 19" W x 24" D (80.7 x 48.2 x 60.9 cm)	725 lbs (328.9 kg)

Regulatory Compliance

EMC	Complies with 2014/30/EU (EMC Directive) CISPR 22 / EN 55022 Class A
Safety	Complies with EN61010-1; Complies with 2014/35/EU (Low Voltage Directive)
CE Mark	Yes
RoHS Compliant	Yes

Specifications continued on the next page >

TS Series

3U to 16U Programmable DC Power Supply • Rugged Current-Fed Power Processing

Specifications (Continued)

AC Input Specifications

1Φ AC Input Voltage 208 Vac (208SP: operating range 187-229 Vac)
1Φ, 2-wire + ground Available on 5 kW models
240 Vac (240SP; operating range 216-264 Vac)

3Φ AC Input Voltage 208 Vac (operating range 187 to 229 Vac)
3Φ, 3-wire + ground 240 Vac (operating range 216 to 264 Vac)
380/400 Vac (operating range 342 to 440 Vac)
415 Vac (operating range 373 to 456 Vac)
440 Vac (operating range 396 to 484 Vac)
480 Vac (operating range 432 to 528 Vac)

AC Input Current Refer to chart of available models

AC Input Frequency 50-400 Hz

Power Factor >0.92 at max power; models with 3Φ AC input
>0.70 at max power; models with 1Φ AC input

AC Input Isolation ±2500 Vac, maximum input voltage to ground

Output Specifications

Voltage Ripple Refer to chart of available models.

Line Regulation Voltage mode: ± 0.004% of full scale
Current mode: ± 0.02% of full scale

Load Regulation Voltage mode: ± 0.01% of full scale
Current mode: ± 0.04% of full scale

Load Transient Response 2 ms to recover within ±1% of regulated output with a 50% to 100% or 100% to 50% step load change

Stability ± 0.10% for 8 hrs. after 30 min. warm-up

Efficiency 84% to 92%; refer to chart of available models

DC Output Isolation ±1000 Vdc, max output voltage to ground
Models Rated ≤1000 Vdc

DC Output Isolation ±(3000 Vdc + Vo/2), max output voltage to ground, where Vo is the max rated voltage
Models Rated >1000 Vdc or Models with +ISO Option

Programming Specifications

Programming Accuracy Voltage: ±0.075% of max voltage rating
Current: ±0.075% of max current rating

Measurement Accuracy Voltage: ±0.2% of max voltage rating
Current: ±0.2% of max current rating

Maximum Slew Rate 100 ms, output voltage change from 0 to 63%
Standard Models 100 ms, output current change from 0 to 63%

Maximum Slew Rate 4 ms, output voltage change from 0 to 63%
Models with High Slew Rate Option (+HS) 8 ms, output current change from 0 to 63%

Trip Settings Range Over Voltage: 10% to 110% max voltage rating
Over Current: 10% to 110% max current rating

Computer Command Protocol Standard Commands for Programmable Instruments (SCPI)

Remote Sense Limits Wired; Available on Models Rated ≤1000 Vdc 3% maximum voltage drop from output to load

Connectivity Specifications

Communication Interfaces (Standard) RS232: DB-9, Female
External User I/O: DB-37, Female

Communication Interfaces (Optional) LXI TCP/IP Ethernet: RJ-45
GPIB: IEEE-488

External User I/O Specifications

Digital Inputs 5 V, 10 kΩ impedance

Digital Monitoring Signals 5 V, 5 mA capacity

Digital Reference Signal 5 V output, 25 mA capacity

Analog Programming Input 0-10 V

Analog Programming Impedance 10 kΩ

Analog Monitoring Signals 0-10 V, 5 mA capacity

Analog Monitoring Impedance 100 Ω

Analog Monitoring Accuracy 0.2% of max rating

Analog Reference Signal 10 V, 5 mA capacity, 1 Ω impedance

Environmental Specifications

Ambient Operating Temperature -25°C to 50°C

Storage Temperature -25°C to +85°C

Humidity Relative humidity up to 95% non-condensing

Temperature Coefficient 0.04%/°C of maximum output voltage
0.06%/°C of maximum output current

Air Cooling 3U and 6U Models Side air inlet, rear exhaust

Air Cooling 4U, 8U, 12U and 16U Models Front and side air inlet, rear exhaust

Water Cooling 25°C maximum inlet temperature
With +WC Option 1.5 GPM minimum flow rate for 5-15 kW units
3.0 GPM minimum flow rate for 20-30 kW units
4.5 GPM minimum flow rate for 40-100 kW units
80 PSI maximum pressure
1/4" NPT male pipe size



TS Series 16U models with removable casters installed. Rack-mount kit included.

Note: Specifications are subject to change without notice. Input voltage specifications are line-to-line.

Product Diagrams – 3U Models

Front Panel

3U Models

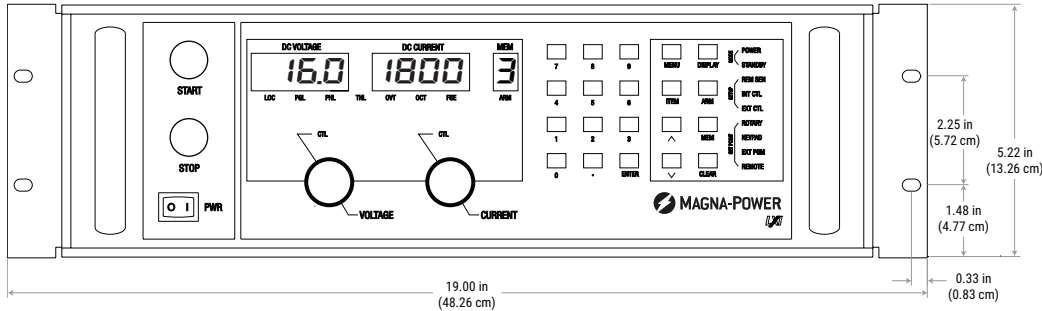

Rear Panel

3U Models

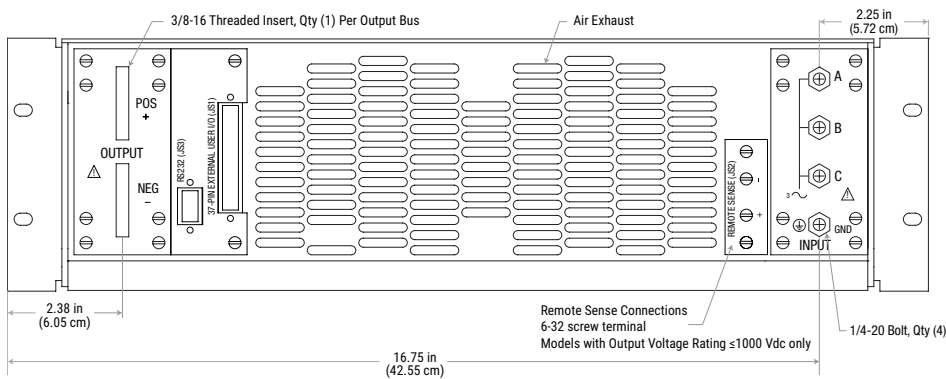

Side Panel and DC Output Bus

3U Models; DC Output Bus for Models 1000 Vdc and Below

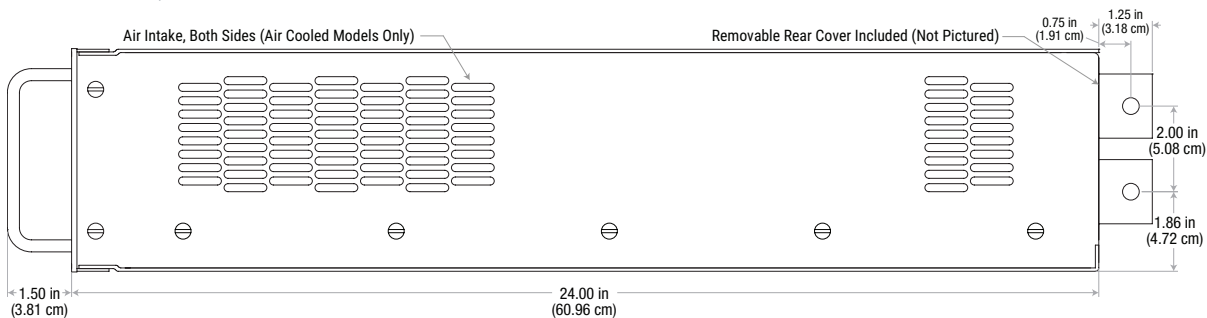

DC Output Bus

3U Models Rated Above 1000 Vdc and with +ISO option

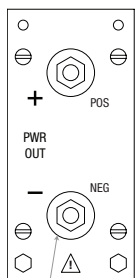

1/4-20 Bolt Qty (2), Models 5-15 kW

Communications

IEEE-488 GPIB (+GPIB) Option

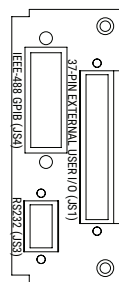

Communications

LXI TCP/IP Ethernet (+LXI) Option

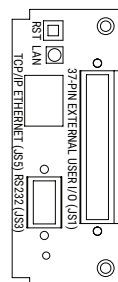

TS Series

3U to 16U Programmable DC Power Supply • Rugged Current-Fed Power Processing

Product Diagram – 4U Models

Front Panel

4U Models

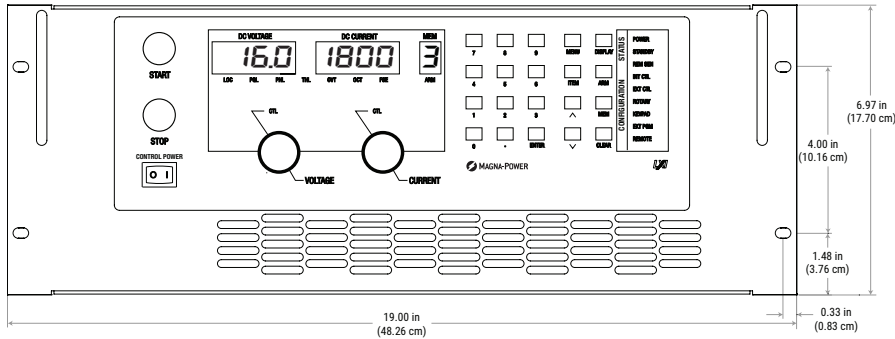

Rear Panel

4U Models

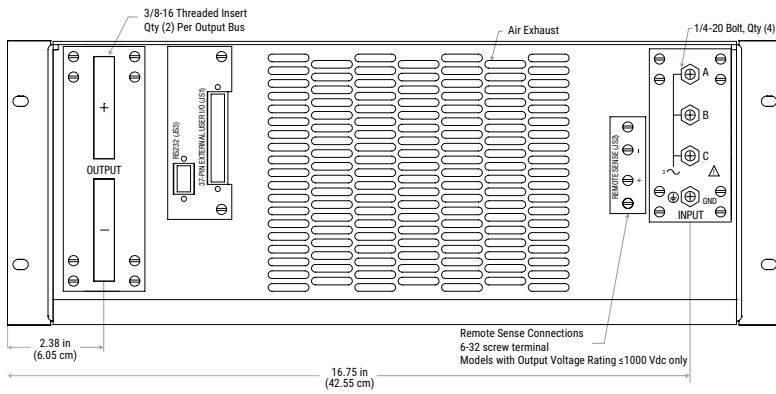

DC Output Bus

4U Models

Rated 125 Vdc to 1000 Vdc

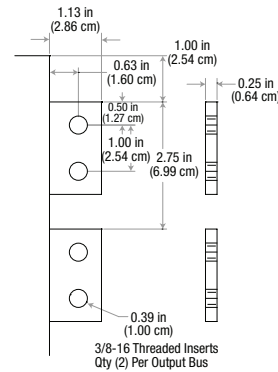

DC Output Bus

4U Models

Models Rated Below 125 Vdc

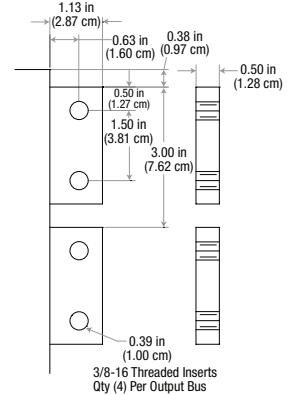

Side Panel

4U Models

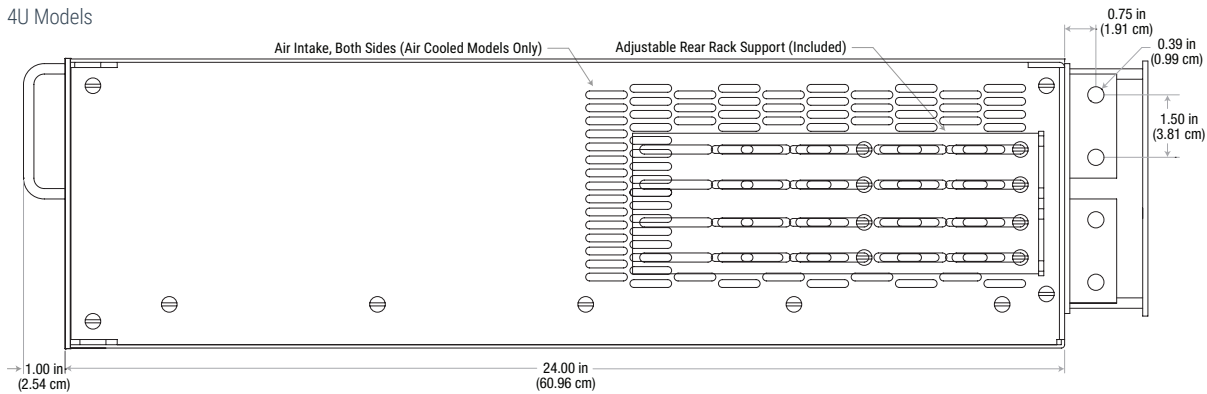

Communications

IEEE-488 GPIB (+GPIB) Option

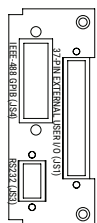

Communications

LXI TCP/IP Ethernet (+LXI) Option

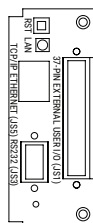

Product Diagrams – 6U Models

Front Panel

6U Models

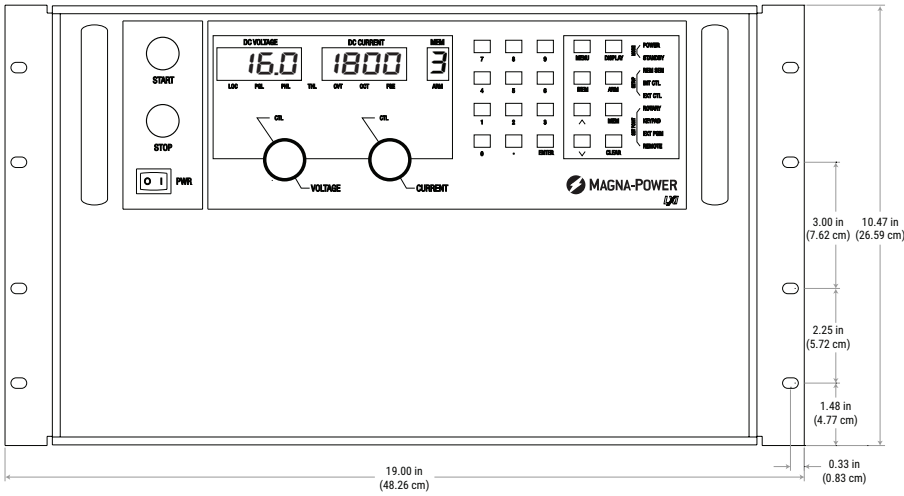

Rear Panel

6U Models

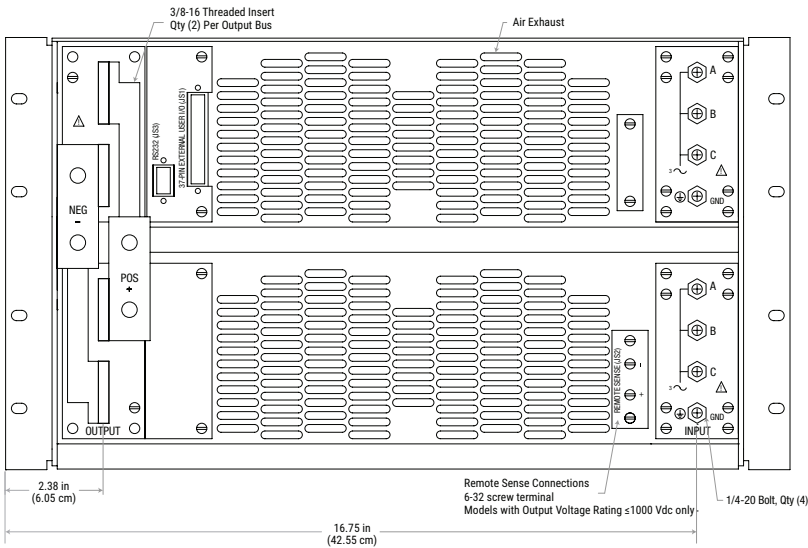

Side Panel

6U Models

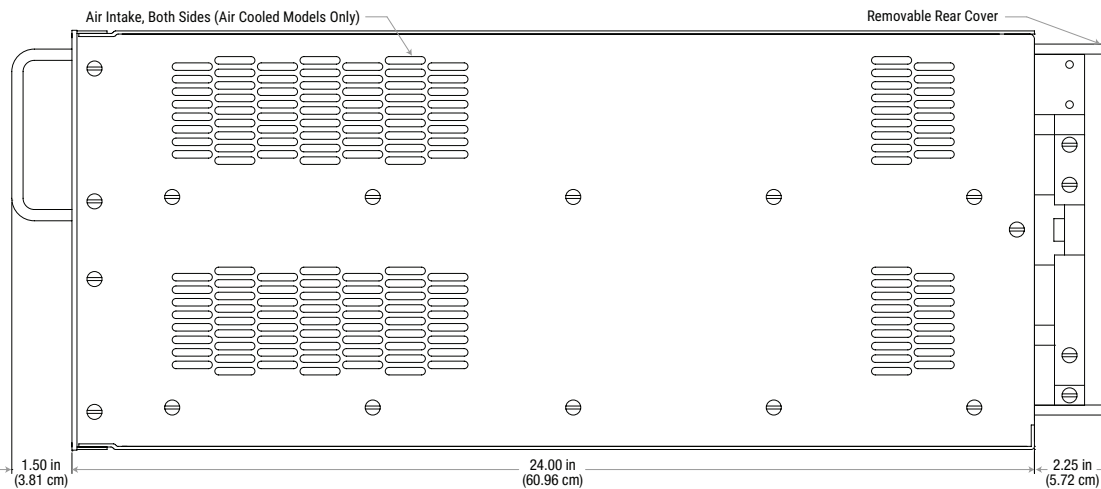

TS Series

3U to 16U Programmable DC Power Supply • Rugged Current-Fed Power Processing

Product Diagrams – 8U Models

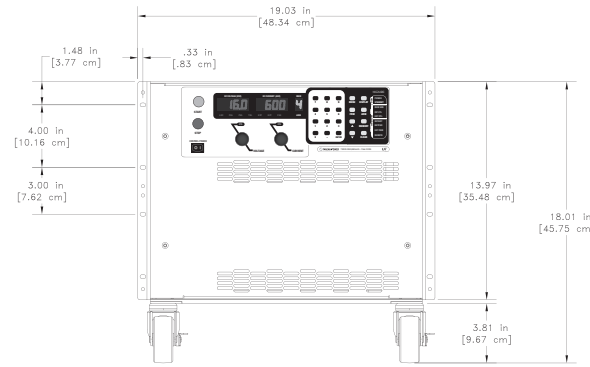
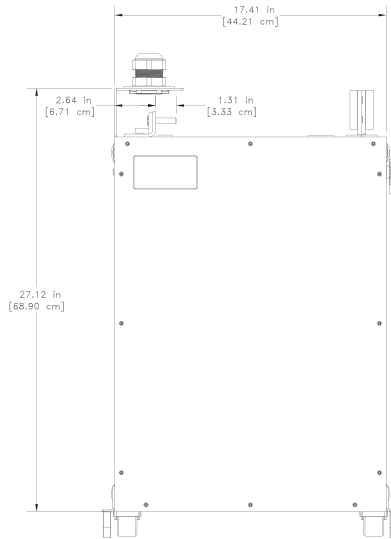
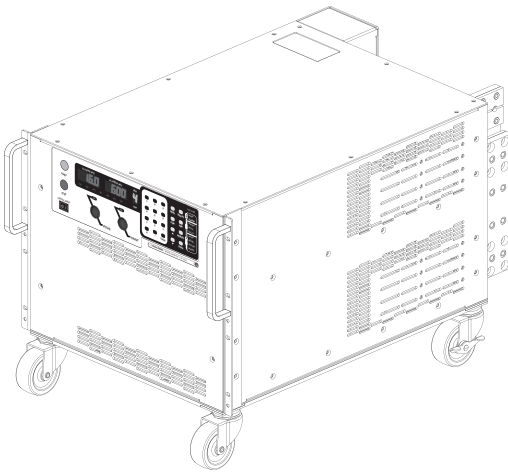
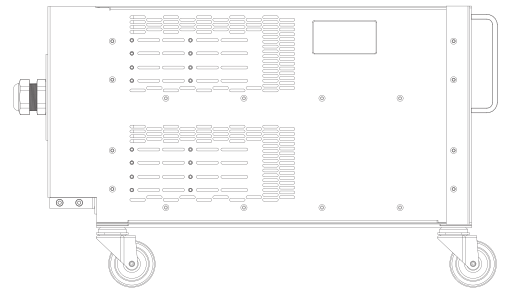
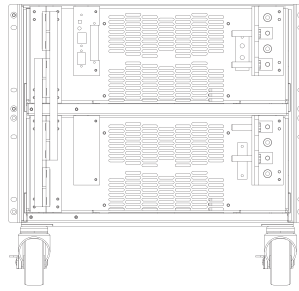
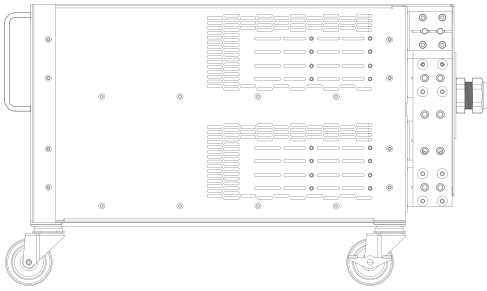

DC Output Bus

8U Models Rated < 125 Vdc

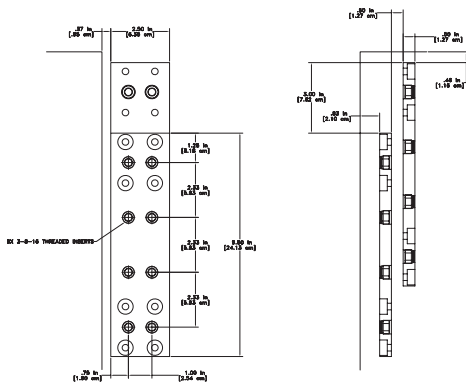

DC Output Bus

8U Models Rated 125 Vdc to 1000 Vdc

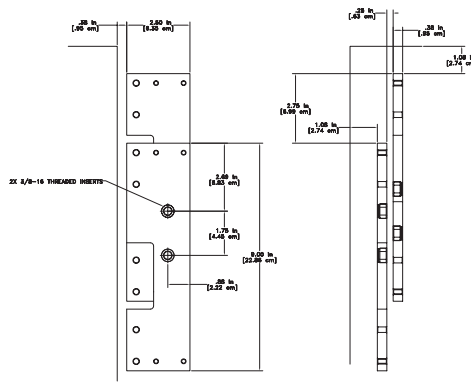

DC Output Bus

8U Models Rated > 1000 Vdc or with +ISO Option

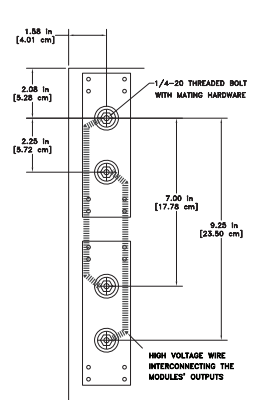

Product Diagrams – 12U Models

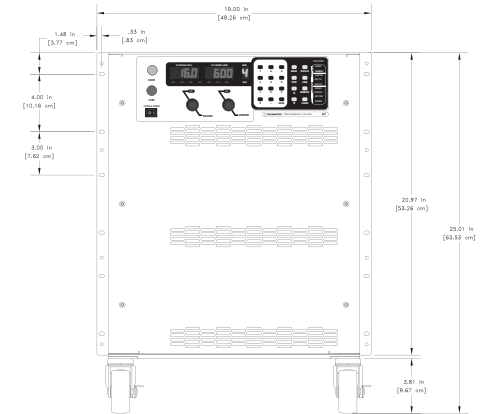
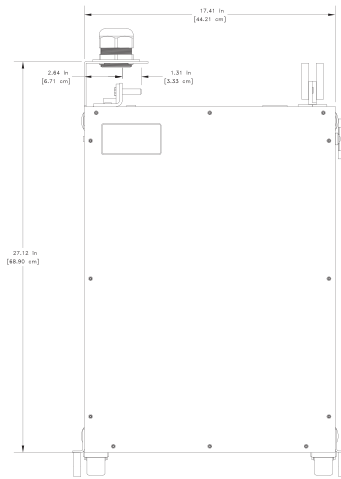
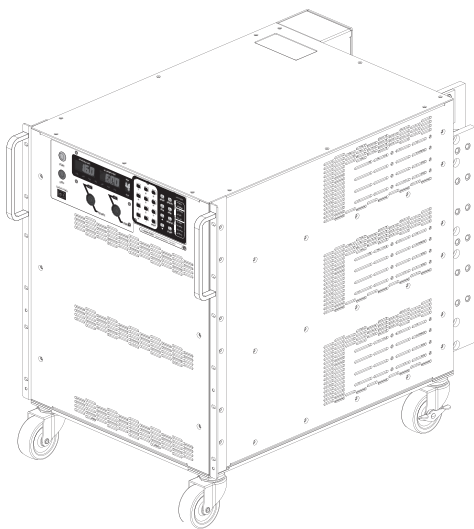
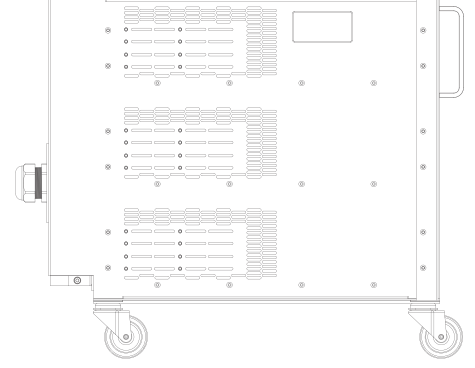
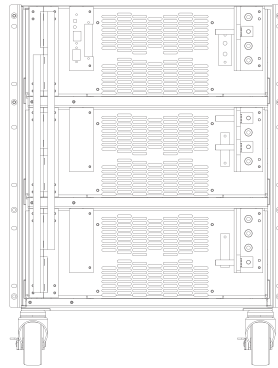
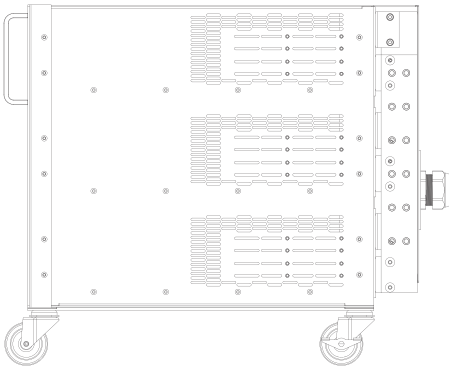

DC Output Bus

12U Models Rated < 125 Vdc

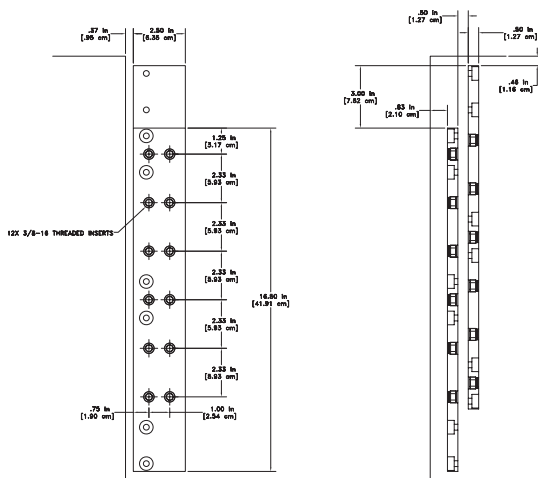

DC Output Bus

12U Models Rated 125 Vdc to 1000 Vdc

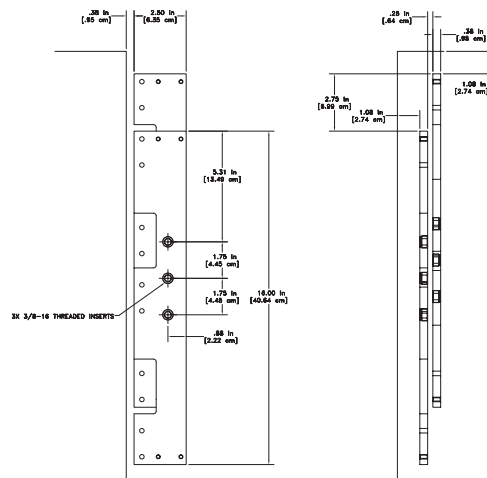

DC Output Bus

12U Models Rated > 1000 Vdc or with +ISO Option

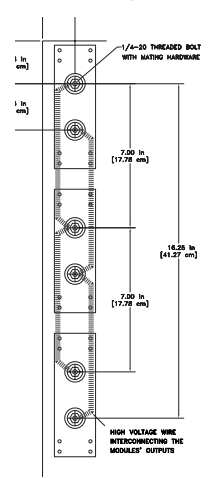

TS Series

3U to 16U Programmable DC Power Supply • Rugged Current-Fed Power Processing

Product Diagrams – 16U Models

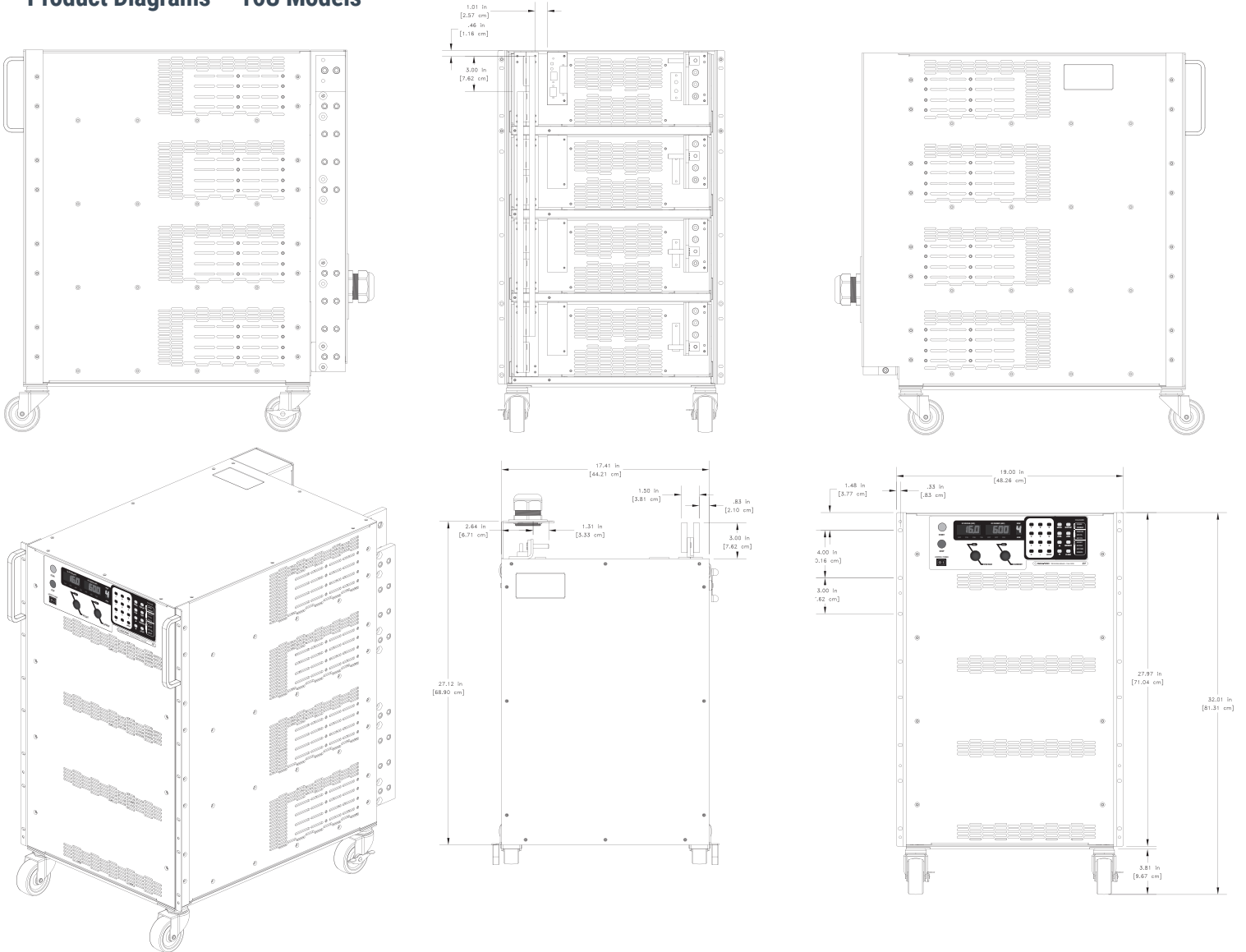

DC Output Bus

16U Models Rated < 125 Vdc

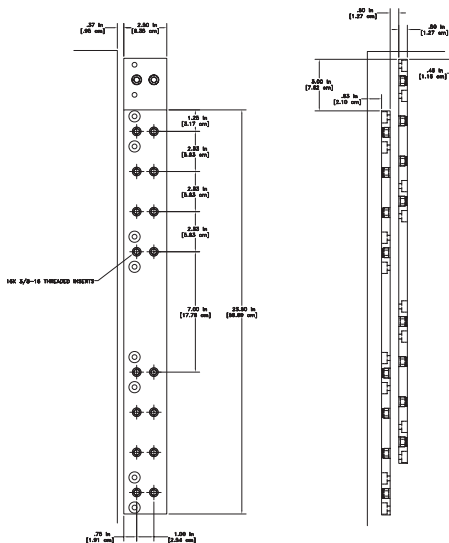

DC Output Bus

16U Models Rated 125 Vdc to 1000 Vdc

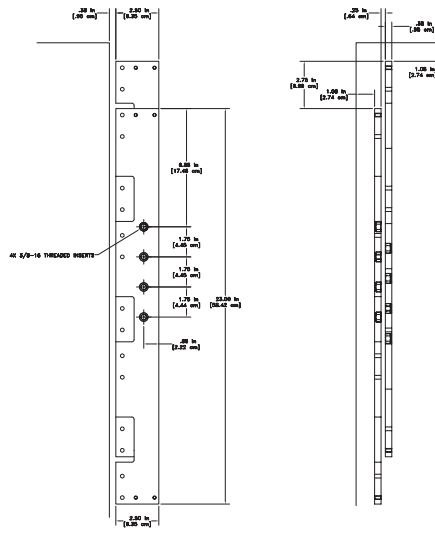

DC Output Bus

16U Models Rated > 1000 Vdc or with +HSO Option

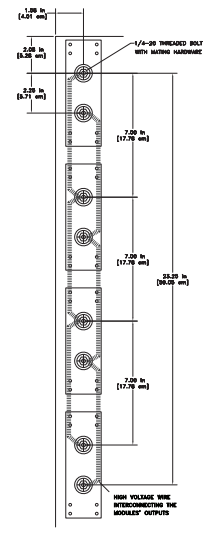

Product Diagrams – With Water Cooling (+WC) Option

Rear Panel

3U Models, With Water Cooling (+WC) Option

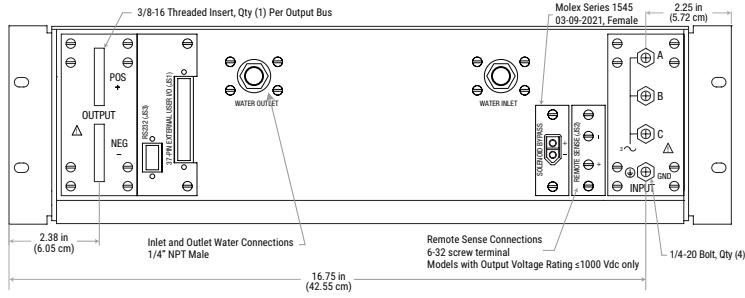

Rear Panel

4U Models, With Water Cooling (+WC) Option

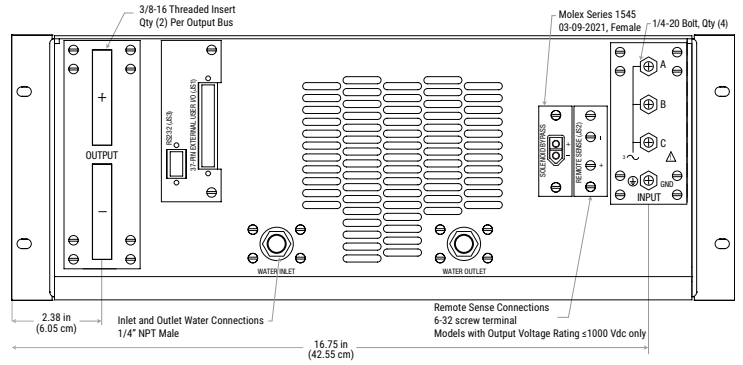

Rear Panel

6U Models, With Water Cooling (+WC) Option

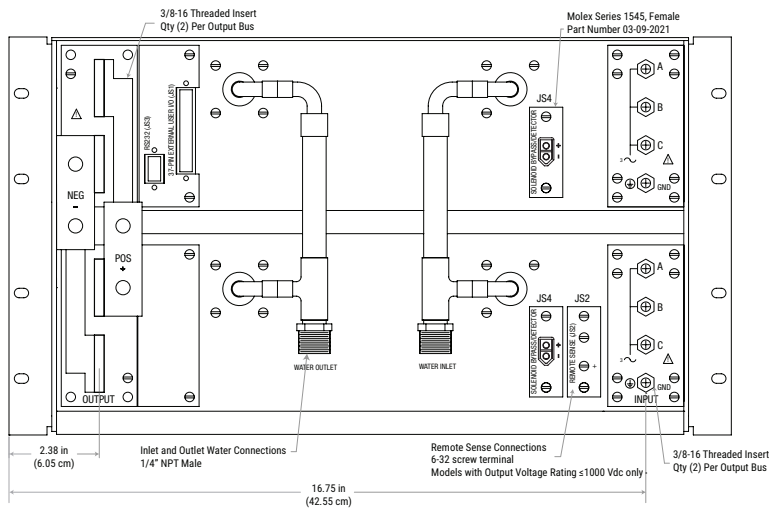

Rear Panel

8U Models, With Water Cooling (+WC) Option

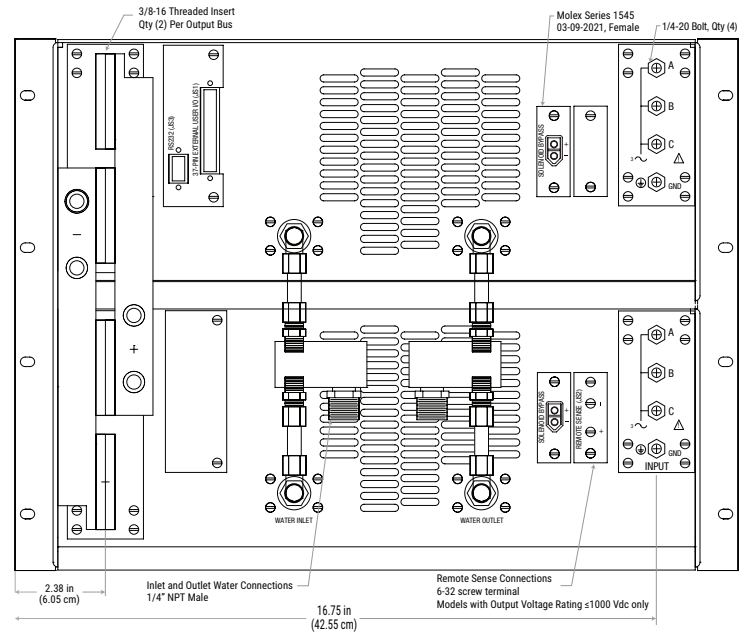

TS Series Front Panel Types

D Version Front Panel

The standard D Version front panel offers front panel provides a digital display with rotary front panel input, isolated 37-pin analog/digital I/O, and a RS232 computer interface. In addition, the D Version front panel provides digital 10-key entry, auto-sequencing with memory capability, and modulation for non-linear power profile emulation.

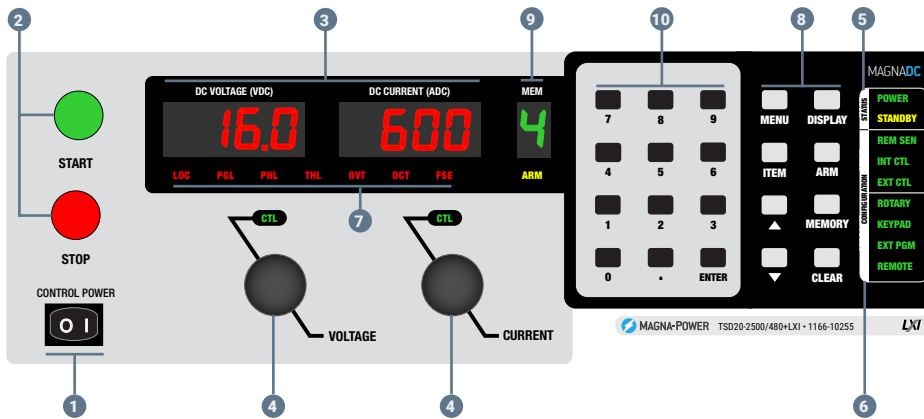

C Version Front Panel

The C Version front panel is blank, providing on a switch to enable control power. All control must be performed by the provided isolated 37-pin analog/digital I/O or through a computer interface.

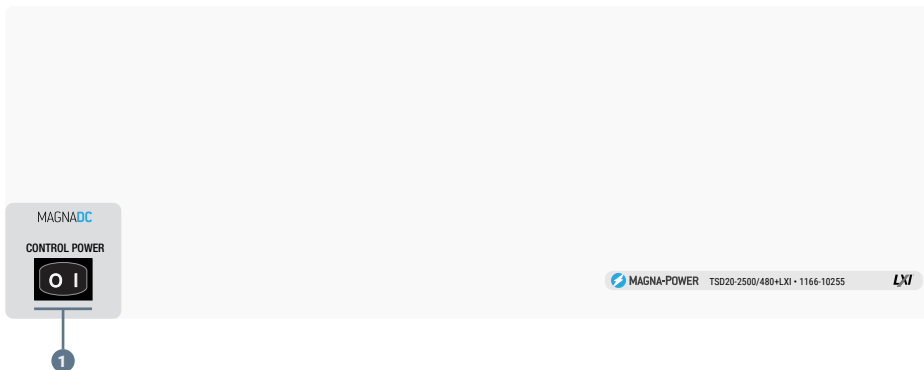

- 1 Power switch energizes control circuits without engaging main power
- 2 Engages and disengages main power via integrated mechanical contactor
- 3 Meters display output voltage, output current, voltage set point, current set point, over voltage trip and over current trip
- 4 Stepless aluminum rotary knob to set voltage and current
- 5 POWER: Indicates power output
STANDBY: Indicates control power only
- 6 Configuration
REM SEN: Remote sense enabled
INT CTL: Front panel start/stop/clear enabled
EXT CTL: External start/stop/clear enabled
ROTARY: Front panel rotary knob input
EXT PGM: External analog voltage-current control
REMOTE: Computer control
- 7 Diagnostic Alarms
LOC/LOCK: Interlock
PGM LN: External input voltage beyond limits
THERM: Over-temperature condition
OVT: Over-voltage protection has tripped
OCT: Over-current protection has tripped
FUSE: Indicates a fuse has cleared
PHASE/PHL: Indicates input AC phase loss
- 8 Function Keys
MENU: Selects function
ITEM: Selects item within function
DISPLAY or V/I DIS: Displays V/I set points
TRIP DIS: Displays OVT and OCT settings
CLEAR: Clears setting or resets fault
ENTER: Selects item
MEM: Sets the memory location
- 9 Memory location indicator, used for autosequencing applications
- 10 Digital input keypad



TS Series 16U models with included rear covers removed. Rack-mount kit included.



TS Series 16U models with included rear covers added. Rack-mount kit included.



TS Series 16U models with removable casters installed. Rack-mount kit included.

MS Series

High-Power Floor-Standing Programmable DC Power Supply • Rugged Current-Fed Power Processing



Overview

The MS Series is built on the same power processing modules as the TS Series, only packaged in a floor-standing cabinet and expanding into higher power levels. The available MS Series models covers a very wide output range, spanning from voltage levels from 5 Vdc up to 6000 Vdc (floating) and current levels up to 4500 Adc. 30 kW model are available in a 31.5" (80.0 cm) high cabinet, while 45 kW to 75 kW models are available in a 51" (129.5 cm) high chassis; all cabinets come with casters. In addition, there are several special low voltage high current models, enabling a more cost-effective solution for these requirements. All MS Series power supplies come standard with isolated 37-pin external I/O, RS232, Remote Interface Software, IVI drivers for integration into a variety of programming environments.

Key Features

- SCPI Remote Programming API
- High Accuracy Measurements
- Master-Slave Functionality
- Remote Sensing
- 37-Pin External User I/O
- RS232 Interface
- Ethernet and GPIB Available
- 0-10V External Analog Inputs
- Programmable Protection Limits
- Fast Transient Response
- Remote Interface Software
- NI LabVIEW™ and IVI Driver
- Interlock Shutdown Input
- Designed and manufactured in the USA

Models

	30 kW	45 kW	60 kW	75 kW		
Max Voltage (Vdc)	Max Current (Adc)				Ripple ¹ (mVrms)	Efficiency
5	2700 ²	3600 ²	4500 ²	N/A	50	84%
10	2700 ²	3600 ²	4500 ²	N/A	40	87%
16	1800	2700	3600	4500	35	87%
20	1500	2250	3000	3750	40	88%
25	1200	1800	2400	3000	40	89%
32	900	1350	1800	2250	40	89%
40	750	1125	1500	1875	40	89%
50	600	900	1200	1500	50	89%
60	498	747	996	1245	60	90%
80	372	558	744	930	60	90%
100	300	450	600	750	60	90%
125	240	360	480	600	100	90%
160	186	279	372	465	120	90%
200	150	225	300	375	125	91%
250	120	180	240	300	130	91%
300	96	144	192	240	160	91%
375	78	117	156	195	170	92%
400	72	108	144	180	180	92%
500	60	90	120	150	220	92%
600	48	72	96	120	250	92%
800	36	54	72	90	300	92%
1000	30	45	60	75	350	92%
1250	24	36	48	60	375	92%
1500	19.8	27.7	39.6	49.5	400	92%
2000	15	22.5	30	37.5	450	92%
3000	9.6	14.4	19.2	24	500	92%
4000	7.2	10.8	14.4	18	550	92%
5000	6	9	12	15	1500	92%
6000	5	7.5	10	12.5	1700	92%
AC Input Voltage (Vac)	Input Current Per Phase (Aac)					
208/240 Vac, 3Φ	103	155	206	258		
380/415 Vac, 3Φ	57	85	113	141		
440/480 Vac, 3Φ	49	73	98	122		

Available Options

- Blocking Diode (+BD)
- High Isolation Output (+ISO)
- High Slew Rate Output (+HS)
- IEEE-488 GPIB Communications (+GPIB)
- LXI TCP/IP Ethernet Communications (+LXI)
- Water Cooling (+WC)

MS Series Model Ordering Guide

There are 106 different models in the MS Series spanning power levels: 30 kW, 45 kW, 60 kW, 75 kW.

To determine the appropriate model:

1. Select the desired Max Voltage (Vdc) from the left-most column.
2. Select the desired Max Current (Adc) from the same row that contains your desired Max Voltage.
3. Construct your model number according to the model ordering guide.

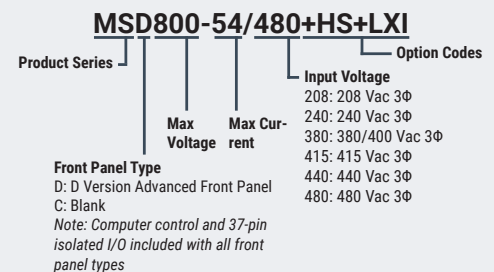

¹ Ripple specified for standard models. Ripple will be higher for models with the High Slew Rate Output (+HS). Refer to option page for more details.

² Low voltage, high current models have a size and input current rating that differ from the rated specifications for models within the same power level. Contact your Magna-Power sales partner for more details.

Specifications

AC Input Specifications

3Φ AC Input Voltage 3Φ, 3-wire + ground Available on all models	208 Vac (operating range 187 to 229 Vac) 240 Vac (operating range 216 to 264 Vac) 380/400 Vac (operating range 342 to 440 Vac) 415 Vac (operating range 373 to 456 Vac) 440 Vac (operating range 396 to 484 Vac) 480 Vac (operating range 432 to 528 Vac)
AC Input Current	Refer to chart of available models
AC Input Frequency	50-60 Hz
Power Factor	>0.92 at max power
AC Input Isolation	±2500 Vac, maximum input voltage to ground

Output Specifications

Voltage Ripple	Refer to chart of available models.
Line Regulation	Voltage mode: ± 0.004% of full scale Current mode: ± 0.02% of full scale
Load Regulation	Voltage mode: ± 0.01% of full scale Current mode: ± 0.04% of full scale
Load Transient Response	2 ms to recover within ±1% of regulated output with a 50% to 100% or 100% to 50% step load change
Stability	± 0.10% for 8 hrs. after 30 min. warm-up
Efficiency	84% to 92%; refer to chart of available models
DC Output Isolation Models Rated ≤1000 Vdc	±1000 Vdc, max output voltage to ground
DC Output Isolation Models Rated >1000 Vdc or Models with +ISO Option	±(3000 Vdc + Vo/2), max output voltage to ground, where Vo is the max rated voltage

Programming Specifications

Programming Accuracy	Voltage: ±0.075% of max voltage rating Current: ±0.075% of max current rating
Measurement Accuracy	Voltage: ±0.2% of max voltage rating Current: ±0.2% of max current rating
Maximum Slew Rate Standard Models	100 ms, output voltage change from 0 to 63% 100 ms, output current change from 0 to 63%
Maximum Slew Rate Models with High Slew Rate Option (+HS)	4 ms, output voltage change from 0 to 63% 8 ms, output current change from 0 to 63%
Trip Settings Range	Over Voltage: 10% to 110% max voltage rating Over Current: 10% to 110% max current rating
Computer Command Protocol	Standard Commands for Programmable Instruments (SCPI)
Remote Sense Limits Wired; Available on Models Rated ≤1000 Vdc	3% maximum voltage drop from output to load

Connectivity Specifications

Communication Interfaces (Standard)	RS232: DB-9, Female External User I/O: DB-37, Female
Communication Interfaces (Optional)	LXI TCP/IP Ethernet: RJ-45 GPIB: IEEE-488

External User I/O Specifications

Digital Inputs	5 V, 10 kΩ impedance
Digital Monitoring Signals	5 V, 5 mA capacity
Digital Reference Signal	5 V output, 25 mA capacity
Analog Programming Input	0-10 V
Analog Programming Impedance	10 kΩ
Analog Monitoring Signals	0-10 V, 5 mA capacity
Analog Monitoring Impedance	100 Ω
Analog Monitoring Accuracy	0.2% of max rating
Analog Reference Signal	10 V, 5 mA capacity, 1 Ω impedance

Physical Specifications

Power Level	Size	Weight
30 kW	31.5" H x 24" W x 31.5" D (80.0 x 55.6 x 80.0 cm)	280 lbs (127.01 kg)
45 kW	51" H x 24" W x 31.5" D (129.5 x 61.0 x 80.0 cm)	395 lbs (179.17 kg)
60 kW	51" H x 24" W x 31.5" D (129.5 x 61.0 x 80.0 cm)	510 lbs (231.33 kg)
75 kW	51" H x 24" W x 31.5" D (129.5 x 61.0 x 80.0 cm)	645 lbs (292.57 kg)

Environmental Specifications

Ambient Operating Temperature	0°C to 50°C
Storage Temperature	-25°C to +85°C
Humidity	Relative humidity up to 95% non-condensing
Temperature Coefficient	0.04%/°C of maximum output voltage 0.06%/°C of maximum output current
Air Cooling Standard	Front air inlet, rear exhaust
Water Cooling With +WC Option	25°C maximum inlet temperature 3.0 GPM minimum flow rate for 30 kW units 4.5 GPM minimum flow rate for 45-75 kW units 80 PSI maximum pressure 1/2" NPT male pipe size

Regulatory Compliance

EMC	Complies with 2014/30/EU (EMC Directive) CISPR 22 / EN 55022 Class A
Safety	Complies with EN61010-1 Complies with 2014/35/EU (Low Voltage Directive)
CE Mark	Yes
RoHS Compliant	Yes

Note: Specifications are subject to change without notice. Input voltage specifications are line-to-line.

MS Series

High-Power Floor-Standing Programmable DC Power Supply • Rugged Current-Fed Power Processing

Product Diagrams

Front Side

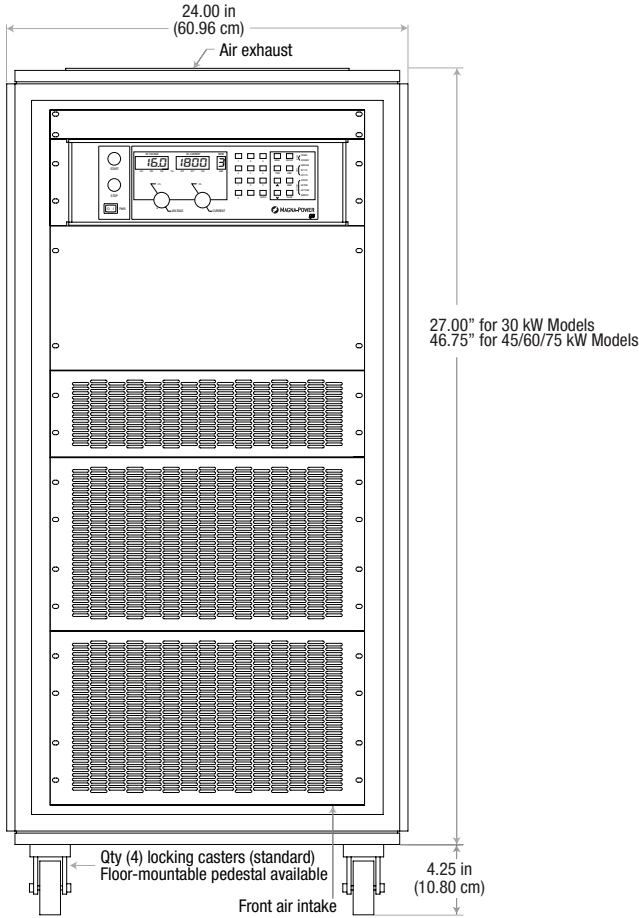

Rear Side

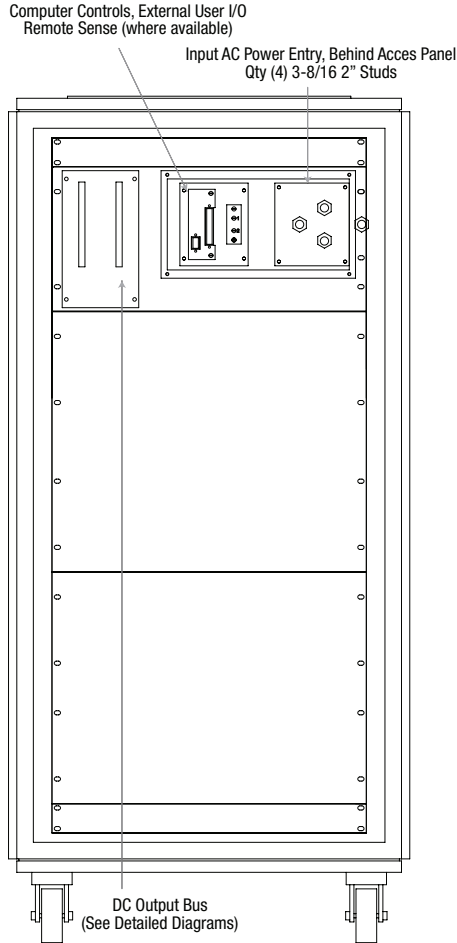

Communications

IEEE-488 GPIB (+GPIB) Option

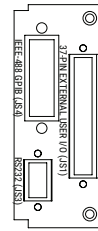

Communications

LXI TCP/IP Ethernet (+LXI) Option

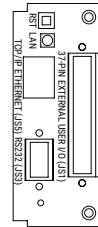

DC Output Bus

Models Rated Below 60 Vdc

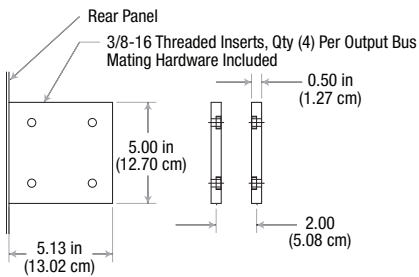

DC Output Bus

Models Rated 60 Vdc through 1000 Vdc

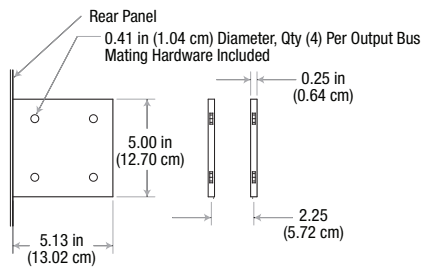

DC Output Bus

Models Rated More than 1000 Vdc or with +ISO Option

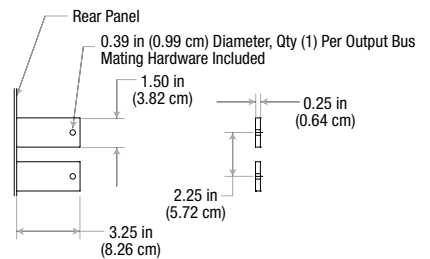



MS Series Front Panel Types

D Version Front Panel

The standard D Version front panel provides a digital display with rotary front panel input, isolated 37-pin analog/digital I/O, and a RS232 computer interface. In addition, the D Version front panel provides digital 10-key entry, auto-sequencing with memory capability, and modulation for non-linear power profile emulation.

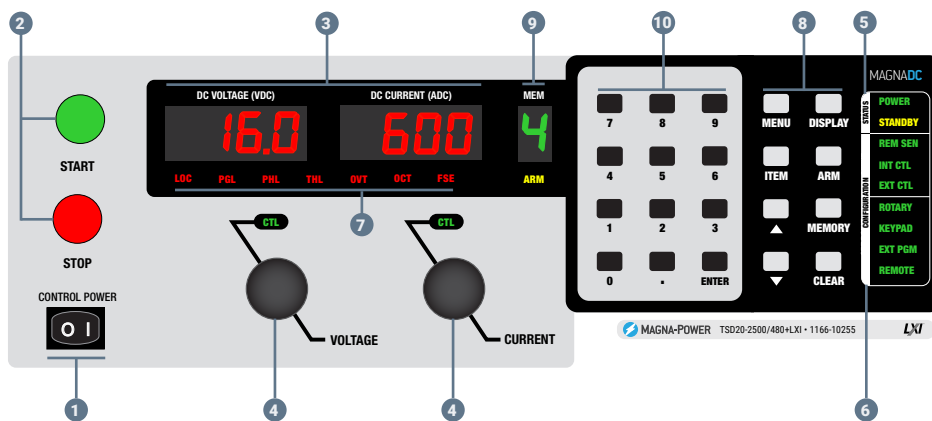

- 1 Power switch energizes control circuits without engaging main power
- 2 Engages and disengages main power via integrated mechanical contactor
- 3 Meters display output voltage, output current, voltage set point, current set point, over voltage trip and over current trip
- 4 Stepless aluminum rotary knob to set voltage and current
- 5 POWER: Indicates power output
STANDBY: Indicates control power only
- 6 Configuration
REM SEN: Remote sense enabled
INT CTL: Front panel start/stop/clear enabled
EXT CTL: External start/stop/clear enabled
ROTARY: Front panel rotary knob input
EXT PGM: External analog voltage-current control
REMOTE: Computer control
- 7 Diagnostic Alarms
LOC/LOCK: Interlock
PGM LN: External input voltage beyond limits
THERM: Over-temperature condition
OVT: Over-voltage protection has tripped
OCT: Over-current protection has tripped
FUSE: Indicates a fuse has cleared
PHASE/PHL: Indicates input AC phase loss
- 8 Function Keys
MENU: Selects function
ITEM: Selects item within function
DISPLAY or V/I DIS: Displays V/I set points
TRIP DIS: Displays OVT and OCT settings
CLEAR: Clears setting or resets fault
ENTER: Selects item
MEM: Sets the memory location
- 9 Memory location indicator, used for autosequencing applications
- 10 Digital input keypad

C Version Front Panel

The C Version front panel is blank, providing on a switch to enable control power. All control must be performed by the provided isolated 37-pin analog/digital I/O or through a computer interface.

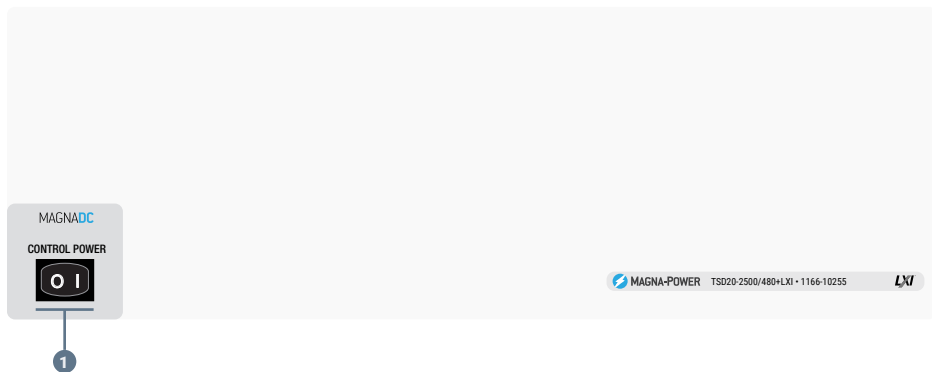

MT Series

High-Power Floor-Standing Programmable DC Power Supply • Expandable into the Multi-Megawatts



100 kW and 150 kW Models



250 kW Models

Models

	100 kW	150 kW	250 kW	500 kW ²	750 kW ²	1000 kW ²		
Max Voltage (Vdc)	Max Current (Aac)						Ripple ¹ (mVrms)	Efficiency
16	6000	N/A	N/A	N/A	N/A	N/A	35	90%
20	5000	N/A	N/A	N/A	N/A	N/A	40	90%
25	4000	N/A	N/A	N/A	N/A	N/A	40	90%
32	3000	4500	N/A	N/A	N/A	N/A	40	90%
40	2500	3750	6000	12000	18000	24000	40	91%
50	2000	3000	5000	10000	15000	20000	50	91%
60	1660	2500	4160	8320	12480	16640	60	91%
80	1250	1850	3000	6000	9000	12000	60	91%
100	1000	1500	2500	5000	7500	10000	60	91%
125	800	1200	2000	4000	6000	8000	100	91%
160	620	900	1500	3000	4500	6000	120	91%
200	500	750	1250	2500	3750	5000	125	91%
250	400	600	1000	2000	3000	4000	130	92%
300	333	500	833	1666	2499	3332	160	92%
375	270	400	660	1320	1980	2640	170	92%
400	250	375	625	1250	1875	2500	180	92%
500	200	300	500	1000	1500	2000	220	92%
600	160	240	400	800	1200	1600	250	92%
800	120	180	300	600	900	1200	300	92%
1000	100	150	250	500	750	1000	400	92%
1250	80	120	200	400	600	800	500	92%
1600	62	90	150	300	450	600	600	92%
2000	50	75	125	250	375	500	800	92%
2500	40	60	100	200	300	400	900	92%
3000	33	50	80	160	240	320	1000	92%
4000	24	36	60	120	180	240	1100	92%
5000	20	30	50	100	150	200	1500	92%
6000	16.6	25	41.6	83.2	124.8	166.4	2000	92%
AC Input Voltage (Vac)	Input Current Per Phase (Aac)							
380/415 Vac, 3Φ	184	276	440	880	1320	1760		
440/480 Vac, 3Φ	159	238	380	760	1140	1520		

Overview

Magna-Power Electronics MT Series uses the same reliable current-fed power processing technology and controls as the rest of the MagnaDC programmable power supply product line, but with larger high-power modules: individual 100 kW, 150 kW and 250 kW power supplies. The high-frequency IGBT-based MT Series units are among the largest standard switched-mode power supplies on the market, minimizing the number of switching components when comparing to smaller module sizes. Scaling in the multi-megawatts is accomplished using the UID47 device, which provides master-slave control: one power supply takes command over the remaining units, for true system operation. As an added safety measure, all MT Series units include an input AC breaker rated for full power.

250 kW modules come standard with an embedded 12-pulse harmonic neutralizer, ensuring low total harmonic distortion (THD). Even higher quality AC waveforms are available with an external additional 500 kW 24-pulse or 1000 kW 48-pulse harmonic neutralizers, designed and manufactured exclusively by Magna-Power for its MT Series products.

MT Series Model Ordering Guide

There are 72 different models in the MS Series spanning power levels: 100 kW, 150 kW, 250 kW.

To determine the appropriate model:

1. Select the desired Max Voltage (Vdc) from the left-most column.
2. Select the desired Max Current (Aac) from the same row that contains your desired Max Voltage.
3. Construct your model number according to the model ordering guide.

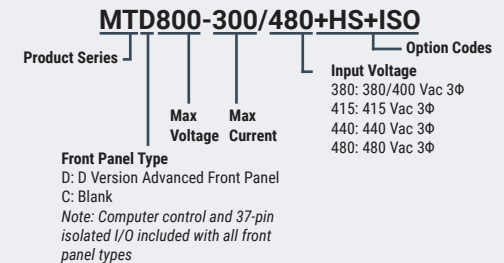

¹ Ripple specified for standard models. Ripple will be higher for models with the High Slew Rate Output (+HS). Refer to option page for more details.

² Power levels greater than 250 kW are achieved by master-slave parallel operation of multiple 250 kW MT Series models. Contact your Magna-Power sales partner for more details on these configurations.

Key Features

- SCPI Remote Programming API
- High Accuracy Measurements
- Master-Slave Functionality
- Remote Sensing
- 37-Pin External User I/O
- RS232 Interface
- Ethernet and GPIB Available
- 0-10V External Analog Inputs
- Programmable Protection Limits
- Fast Transient Response
- Remote Interface Software
- NI LabVIEW™ and IVI Driver
- Interlock Shutdown Input
- Designed and manufactured in the USA

Specifications

AC Input Specifications

3Φ AC Input Voltage 3Φ, 3-wire + ground Available on all models	380/400 Vac (operating range 342 to 440 Vac) 415 Vac (operating range 373 to 456 Vac) 440 Vac (operating range 396 to 484 Vac) 480 Vac (operating range 432 to 528 Vac)
AC Input Current	Refer to chart of available models
AC Input Frequency	50-60 Hz
Power Factor	> 0.92 at max power; 100 kW and 150 kW models > 0.96 at maximum power; 250 kW models
AC Input Isolation	±2500 Vac, maximum input voltage to ground

Output Specifications

Voltage Ripple	Refer to chart of available models.
Line Regulation	Voltage mode: ± 0.004% of full scale Current mode: ± 0.02% of full scale
Load Regulation	Voltage mode: ± 0.01% of full scale Current mode: ± 0.04% of full scale
Load Transient Response	2 ms to recover within ±1% of regulated output with a 50% to 100% or 100% to 50% step load change
Stability	± 0.10% for 8 hrs. after 30 min. warm-up
Efficiency	90% to 92%; refer to chart of available models
DC Output Isolation Models Rated ≤1000 Vdc	±1000 Vdc, max output voltage to ground
DC Output Isolation Models Rated >1000 Vdc or Models with +ISO Option	±6000 Vdc, max output voltage to ground

Programming Specifications

Programming Accuracy	Voltage: ±0.075% of max voltage rating Current: ±0.075% of max current rating
Measurement Accuracy	Voltage: ±0.2% of max voltage rating Current: ±0.2% of max current rating
Maximum Slew Rate Standard Models	100 ms, output voltage change from 0 to 63% 100 ms, output current change from 0 to 63%
Maximum Slew Rate Models with High Slew Rate Option (+HS)	4 ms, output voltage change from 0 to 63% 8 ms, output current change from 0 to 63%
Trip Settings Range	Over Voltage: 10% to 110% max voltage rating Over Current: 10% to 110% max current rating
Computer Command Protocol	Standard Commands for Programmable Instruments (SCPI)
Remote Sense Limits Wired; Available on Models Rated ≤1000 Vdc	3% maximum voltage drop from output to load

Available Options

- Blocking Diode (+BD)
- High Isolation Output (+ISO)
- High Slew Rate Output (+HS)
- IEEE-488 GPIB Communications (+GPIB)
- LXI TCP/IP Ethernet Communications (+LXI)

External User I/O Specifications

Digital Inputs	5 V, 10 kΩ impedance
Digital Monitoring Signals	5 V, 5 mA capacity
Digital Reference Signal	5 V output, 25 mA capacity
Analog Programming Input	0-10 V
Analog Programming Impedance	10 kΩ
Analog Monitoring Signals	0-10 V, 5 mA capacity
Analog Monitoring Impedance	100 Ω
Analog Monitoring Accuracy	0.2% of max rating
Analog Reference Signal	10 V, 5 mA capacity, 1 Ω impedance

Physical Specifications

Power Level	Size	Weight
100 kW	67" H x 48" W x 31.5" D (170.2 x 121.9 x 80.0 cm)	1600 lbs (725.8 kg)
150 kW	67" H x 48" W x 31.5" D (170.2 x 121.9 x 80.0 cm)	2100 lbs (952.5 kg)
250 kW	67" H x 72" W x 31.5" D (170.2 x 182.9 x 80.0 cm)	3300 lbs (1496.9 kg)

Environmental Specifications

Ambient Operating Temperature	0°C to 50°C
Storage Temperature	-25°C to +85°C
Humidity	Relative humidity up to 95% non-condensing
Air Flow	Front and rear intake, top exhaust
Temperature Coefficient	0.04%/°C of maximum output voltage 0.06%/°C of maximum output current

Regulatory Compliance

EMC	Complies with 2014/30/EU (EMC Directive) CISPR 22 / EN 55022 Class A
Safety	Complies with EN61010-1 Complies with 2014/35/EU (Low Voltage Directive)
CE Mark	Yes
RoHS Compliant	Yes

Connectivity Specifications

Communication Interfaces (Standard)	RS232: DB-9, Female External User I/O: DB-37, Female
Communication Interfaces (Optional)	LXI TCP/IP Ethernet: RJ-45 GPIB: IEEE-488

MT Series

High-Power Floor-Standing Programmable DC Power Supply • Expandable into the Multi-Megawatts

Product Diagrams

Front Side

100 kW and 150 kW Models

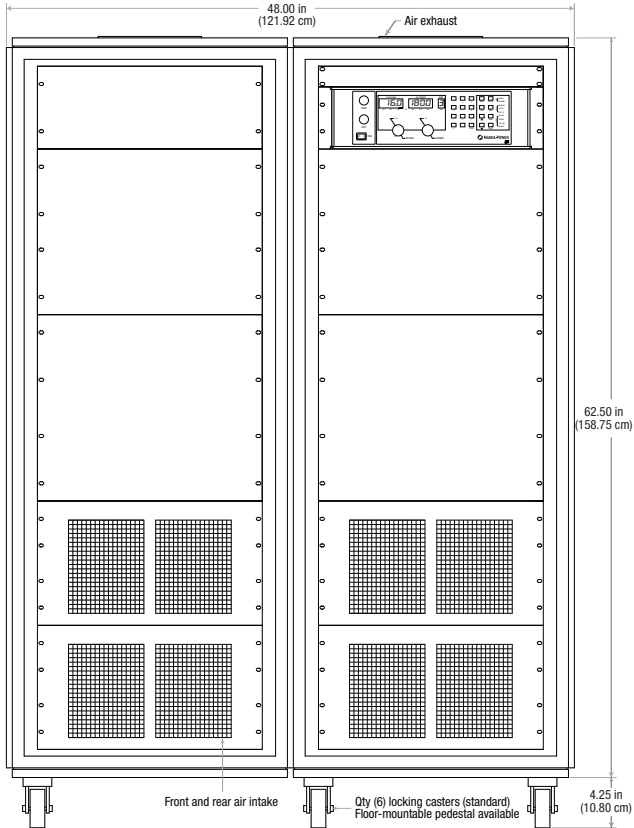

Rear Side

100 kW and 150 kW Models

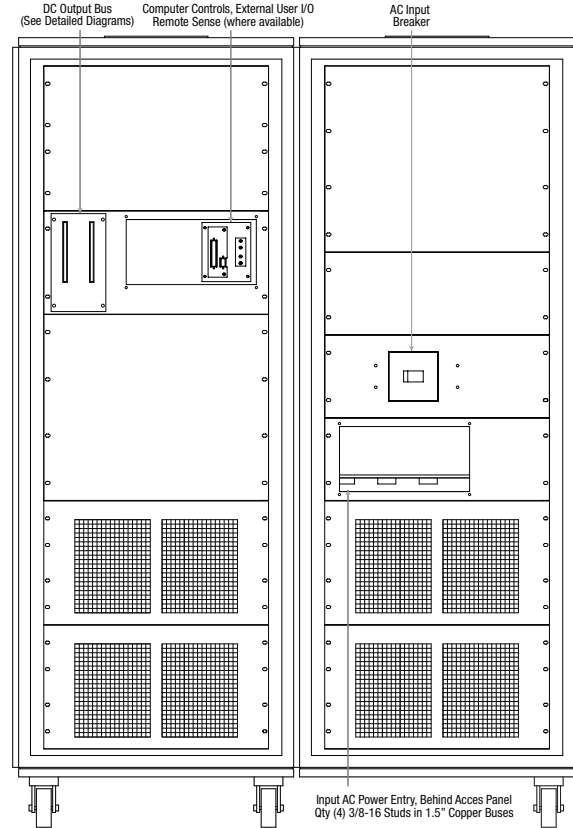

Qty (8) 250 kW MT Series units in master-slave parallel to form a 2 MW system

Front Side
250 kW Models

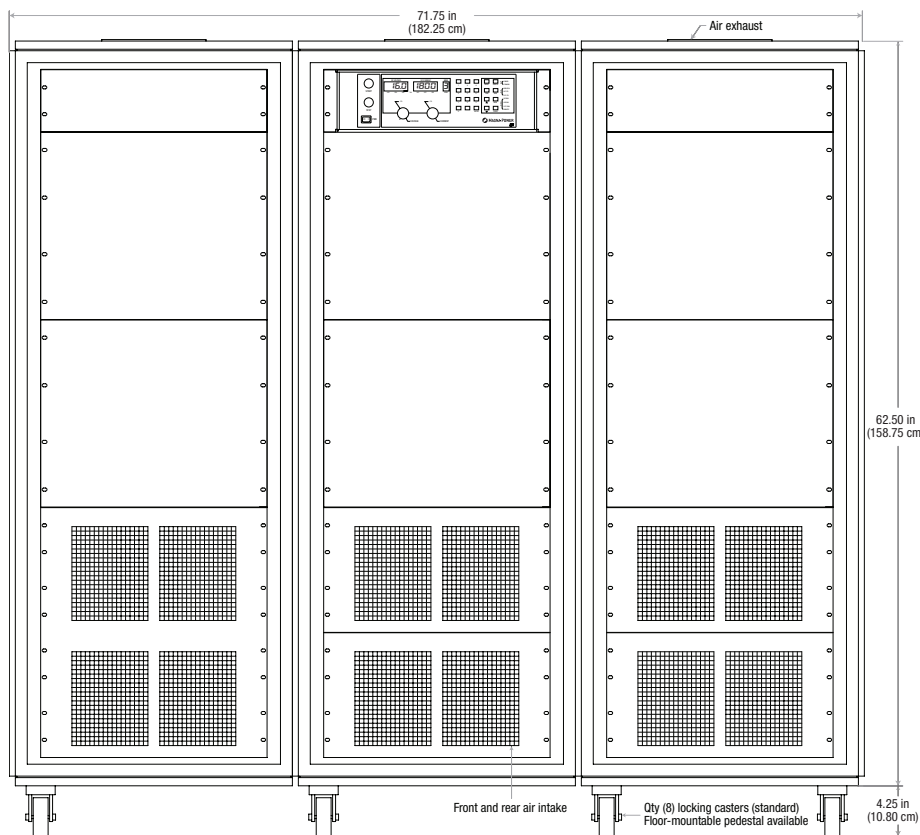

DC Output Bus
Models Rated Below 60 Vdc

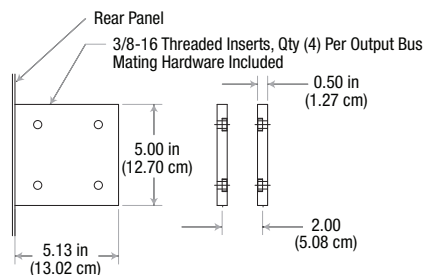

DC Output Bus
Models Rated 60 Vdc through 1000 Vdc

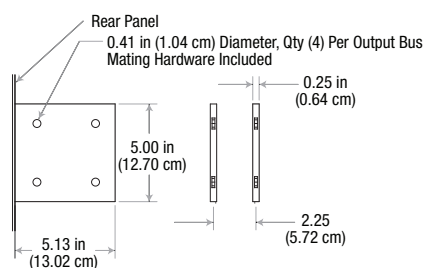

DC Output Bus
Models Rated More than 1000 Vdc or with +ISO Option

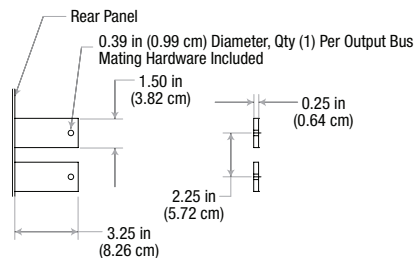

Rear Side
250 kW Models

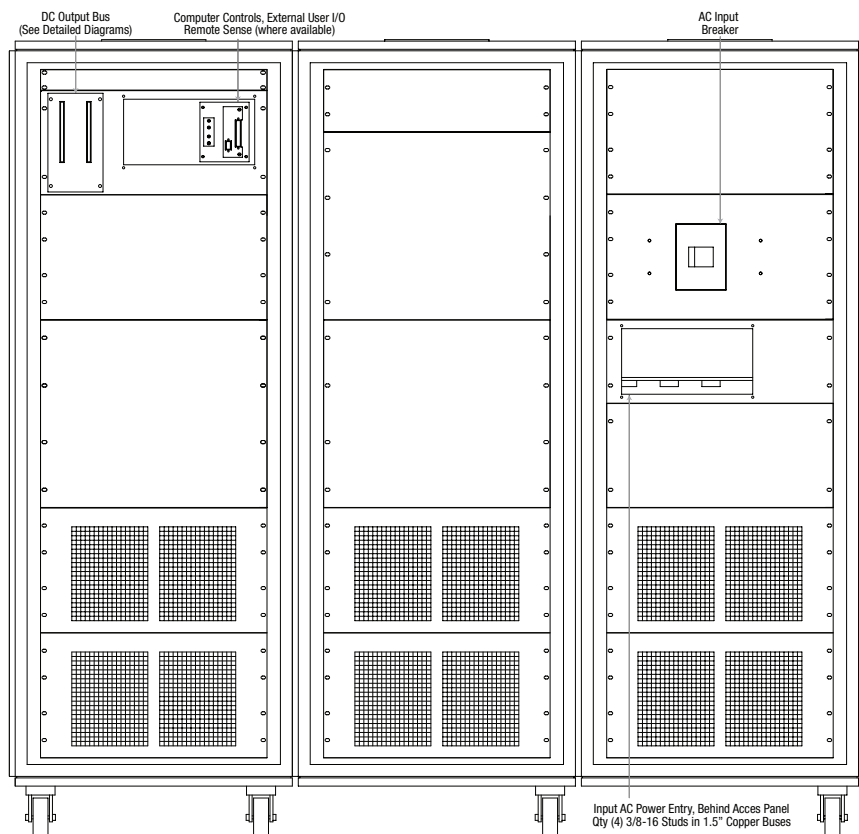

Communications
IEEE-488 GPIB (+GPIB) Option

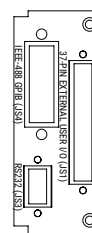

Communications
LXI TCP/IP Ethernet (+LXI) Option

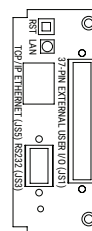

MT Series

High-Power Floor-Standing Programmable DC Power Supply • Expandable into the Multi-Megawatts

MT Series Front Panel Types

D Version Front Panel

The standard D Version front panel offers front panel provides a digital display with rotary front panel input, isolated 37-pin analog/digital I/O, and a RS232 computer interface. In addition, the D Version front panel provides digital 10-key entry, auto-sequencing with memory capability, and modulation for non-linear power profile emulation.

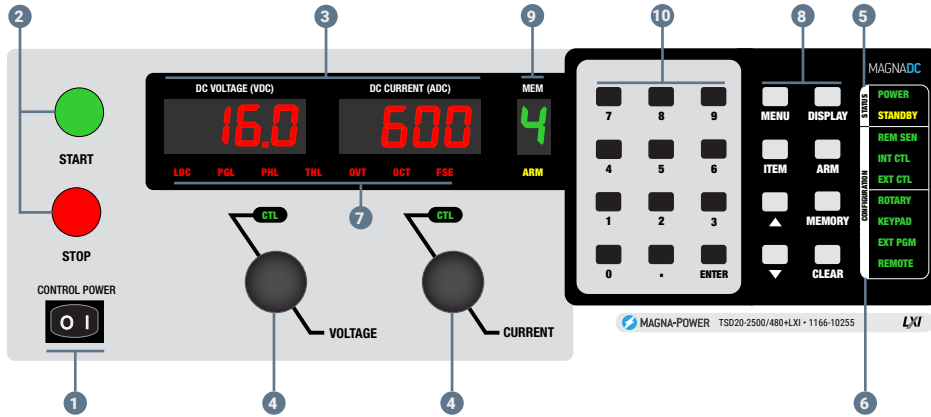

- 1 Power switch energizes control circuits without engaging main power
- 2 Engages and disengages main power via integrated mechanical contactor
- 3 Meters display output voltage, output current, voltage set point, current set point, over voltage trip and over current trip
- 4 Stepless aluminum rotary knob to set voltage and current
- 5 POWER: Indicates power output
STANDBY: Indicates control power only
- 6 Configuration
REM SEN: Remote sense enabled
INT CTL: Front panel start/stop/clear enabled
EXT CTL: External start/stop/clear enabled
ROTARY: Front panel rotary knob input
EXT PGM: External analog voltage-current control
REMOTE: Computer control
- 7 Diagnostic Alarms
LOC/LOCK: Interlock
PGM LN: External input voltage beyond limits
THERM: Over-temperature condition
OVT: Over-voltage protection has tripped
OCT: Over-current protection has tripped
FUSE: Indicates a fuse has cleared
PHASE/PHL: Indicates input AC phase loss
- 8 Function Keys
MENU: Selects function
ITEM: Selects item within function
DISPLAY or V/I DIS: Displays V/I set points
TRIP DIS: Displays OVT and OCT settings
CLEAR: Clears setting or resets fault
ENTER: Selects item
MEM: Sets the memory location
- 9 Memory location indicator, used for auto-sequencing applications
- 10 Digital input keypad

C Version Front Panel

The C Version front panel is blank, providing on a switch to enable control power. All control must be performed by the provided isolated 37-pin analog/digital I/O or through a computer interface.

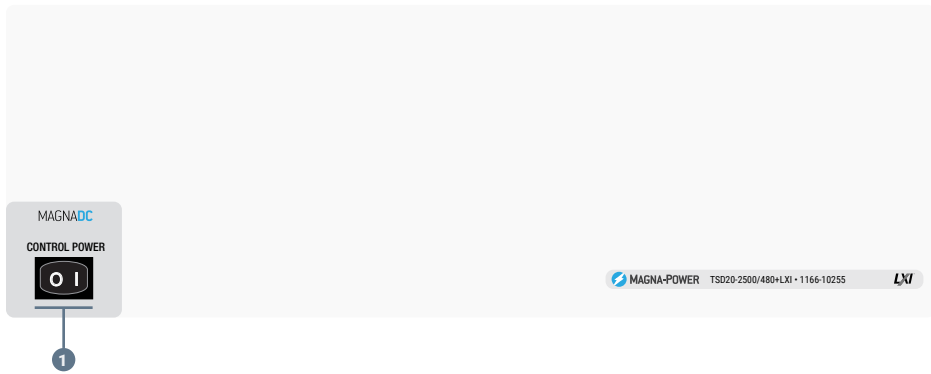

MT Series Harmonic Neutralization

Magna-Power's Harmonic Neutralizers eliminate families of harmonic components by multiplying the number of input phases with specially wound magnetic components, reducing the total harmonic distortion (THD). These magnetic components, in combination with equally loaded, high-power DC power supplies, offer a cost-effective solution to maintaining power quality at acceptable levels, enabling applications to benefit from Magna-Power's reliable high-frequency switch-mode power supplies, extended into multi-megawatts. A 12-pulse Harmonic Neutralizer is embedded in all 250 kW models and its installation is transparent to the end user. For applications demanding an even better THD level than that provided by a 12-pulse waveform, external 24-pulse and 48-pulse harmonic neutralizers are available from Magna-Power.

Understanding AC Harmonic Waveforms

The following figures are representative of expected AC current waveforms for the various pulses available from Magna-Power Electronics power supplies. Standard models 1.5 kW through 150 kW produce 6-pulse waveforms, while 250 kW models produce 12-pulse waveforms. Magna-Power Electronics Harmonic Neutralizers suppress families of harmonics by increasing the number of power phases. It can be used when multiple power supplies are used in series or parallel and are equally loaded. Harmonic Neutralizers can produce 12-pulse, 18-pulse, 24-pulse, or 48-pulse waveforms which have harmonic current components on the order of $12n \pm 1$, $18n \pm 1$, $24n \pm 1$, or $48n \pm 1$, respectively. The following figures show the theoretical difference for waveforms with a different number of pulses. Harmonic Neutralizers are protected with appropriate sized primary-side circuit breakers.

Why Neutralize Harmonics?

Input current harmonics are a by-product of nearly all power supplies. Power can only be delivered to the load if the frequency and phase of the voltage and current match. For a three phase power supply using a three phase input rectifier, the input current has a theoretical spectrum of $6n \pm 1$ where n is an integer incrementing from 1; this is known as a 6-pulse waveform. This means that a power supply with a three phase input rectifier will produce input currents at 1, 5, 7, 11, 13, 17, 19 ... times the fundamental frequency. The theoretical magnitude decays as the reciprocal of the harmonic component. The 5th and 7th harmonic components have magnitudes of 20% and 14% of the fundamental component, respectively. Harmonics currents in power systems can find unusual paths and can cause problems if the magnitude is significant and there are loads sensitive to harmonic frequencies. For example, lighting ballasts have series connected capacitors and inductors which can be excited by harmonic currents. IEEE has introduced standard, IEEE 519, which defines recommended limits. Implementing this standard requires a knowledge of the power system and other loads producing harmonics. Unfortunately, the standard can allow the same power supply to possibly exceed limits in one application and not in another. In the same respect, a power supply may or may not cause a harmonic related problem with or without meeting IEEE 519. The best solution to minimize the risk of a harmonic problem is to eliminate the harmonic current at the source.

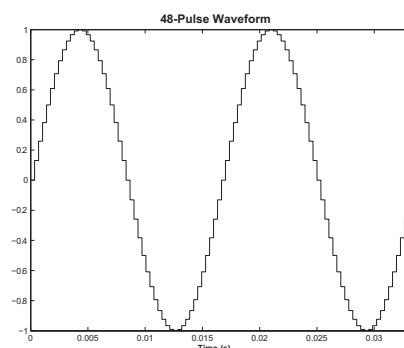
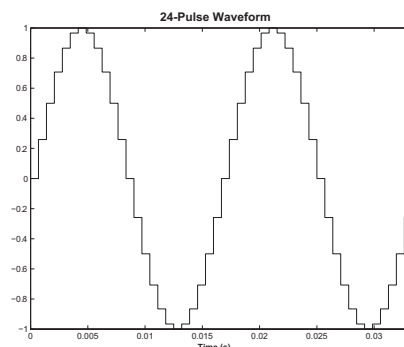
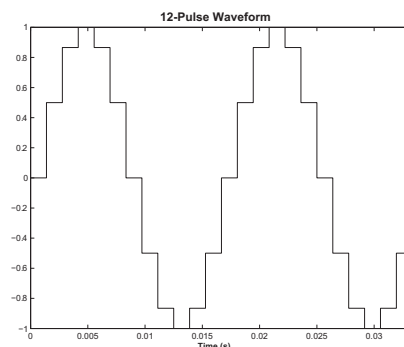
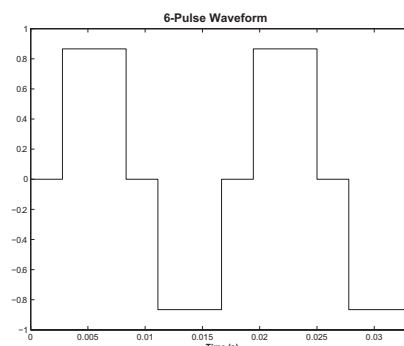

External Harmonic Neutralizers

Model	Power Level	AC Input	Number of Pulses	Weight	Dimensions
HN500/380	500 kW	380/400 Vac 50 Hz	24	3003 lbs (1362 kgs)	62.5" H x 24" W x 31.5" D (158.8 x 70.0 x 80.0 cm)
HN500/415	500 kW	415 Vac 50 Hz	24	3003 lbs (1362 kgs)	62.5" H x 24" W x 31.5" D (158.8 x 70.0 x 80.0 cm)
HN500/440	500 kW	440 Vac 60 Hz	24	3003 lbs (1362 kgs)	62.5" H x 24" W x 31.5" D (158.8 x 70.0 x 80.0 cm)
HN500/480	500 kW	480 Vac 60 Hz	24	3003 lbs (1362 kgs)	62.5" H x 24" W x 31.5" D (158.8 x 70.0 x 80.0 cm)
HN1000/380	1000 kW	380/400 Vac 50 Hz	48	9012 lbs (4087 kgs)	62.5" H x 72" W x 31.5" D (158.8 x 182.9 x 80.0 cm)
HN1000/415	1000 kW	415 Vac 50 Hz	48	9012 lbs (4087 kgs)	62.5" H x 72" W x 31.5" D (158.8 x 182.9 x 80.0 cm)
HN1000/440	1000 kW	440 Vac 60 Hz	48	9012 lbs (4087 kgs)	62.5" H x 72" W x 31.5" D (158.8 x 182.9 x 80.0 cm)

Blocking Diode (+BD)

The integrated **Blocking Diode (+BD)** option provides an internally heat-sunk protection diode on the positive output terminal of a MagnaDC programmable DC power supply. This diode protects the product's output from reverse voltage up to 1200 Vdc. All voltage sensing is performed after the protection diode—at the product's output terminals—making the diode's operation completely transparent to the performance of the power supply.

The +BD option is recommended for applications where there is significant back-emf or the possibility of a DC output voltage that could exceed the power supply's output voltage rating, such as:

- DC motor drives
- Battery and capacitor charging
- Large electromagnets

In these applications, the integrated blocking diode can be used to prevent back-emf from the energy stored in the load into the power supply's output. Furthermore, the integrated blocking diode will prevent the power supply's internal bleed resistance from discharging the energy stored in the load when the power supply is off or in standby.

Availability

The +BD option is available for models with maximum output voltage rating as specified for the following product series:

- TS Series, models rated from 40 Vdc to 1000 Vdc
- MS Series, models rated from 40 Vdc to 1000 Vdc
- MT Series, models rated from 125 Vdc to 1000 Vdc

The +BD option cannot be combined with the +ISO option.

Specifications

Additional Specifications for Blocking Diode (+BD) Option

Reverse Voltage Rating

Models Rated 1200 Vdc
125 Vdc to 1000 Vdc

Reverse Voltage Rating

Models Rated 200 Vdc
Below 125 Vdc

Additional Losses

Models Rated Up to 1.4%
125 Vdc to 1000 Vdc

Additional Losses

Models Rated Up to 2.5%
Below 125 Vdc

High Isolation Output (+ISO)

Certain applications require floating the output voltage to values beyond the power supply isolation rating. Magna-Power's **High Isolation Output Option (+ISO)** enables a TS Series, MS Series or MT Series model with a peak output voltage rating of 250 Vdc through 1000 Vdc to be rated for a higher voltage output isolation. Improved isolation is achieved by a novel output stage with improved controller isolation. In addition to being able to float the power supply to a higher output voltage, this option also enables lower voltage units to be tied together in series up to its new higher isolation rating, in accordance with the table in the Specifications section below.

Availability

The +ISO option is available for models with maximum output voltage rating as specified for the following product series:

- TS Series, models rated from 250 Vdc to 1000 Vdc
- MS Series, models rated from 250 Vdc to 1000 Vdc
- MT Series, models rated from 250 Vdc to 1000 Vdc

The +ISO option cannot be combined with the +BD or +WC options. Addition of the +ISO option will cause the product's wired remote sense feature to be removed.

Specifications

Output Isolation Rating for Various Configurations

Product Series	Output Isolation Standard, No Option	Output Isolation for Models Rated 250-1000 Vdc With +ISO Option	Output Isolation for Models Rated Above 1000 Vdc; Standard, No Option Necessary
SL Series	±1000 Vdc	N/A	N/A
XR Series	±1000 Vdc	N/A	±(1500 Vdc + Vo/2)
TS Series	±1000 Vdc	±(3000 Vdc + Vo/2)	±(3000 Vdc + Vo/2)
MS Series	±1000 Vdc	±(3000 Vdc + Vo/2)	±(3000 Vdc + Vo/2)
MT Series	±1000 Vdc	±6000 Vdc	±6000 Vdc

High Slew Rate Output (+HS)

The High Slew Rate Output (+HS) solves several limitations inherent in switching power supply design. Rapid voltage transitions require internal electronics to supply the energy to charge and discharge output capacitors. Peak currents internal to the power supply define slew rate; utilizing less capacitance enables voltage transitions in shorter time periods. Additionally, less capacitance reduces requirements for discharge demands during open circuit conditions.

The standard output stage Magna-Power Electronics power supplies has been designed to provide the lowest possible output ripple voltage within the constraints of available components, size, and cost. Part of the output stage consists of a bank of aluminum electrolytic capacitors which has the desired electrical properties to provide this function. These components require bleed resistors to discharge any voltage when the power supply has no load and is disabled. While the presence of these components and the resulting performance are normally industry accepted, there are applications where lower output capacitance and lower loss bleed resistors are extremely desirable and higher ripple voltage is acceptable. To meet this need, a high-slew rate option is available which has an output stage consisting of low capacitance film and aluminum electrolytic capacitors and lower loss bleed resistors. Applications for the high-slew rate option include battery charging, photovoltaic emulation, power waveform generation, and medium speed power pulsing. These applications all benefit from higher bandwidth and in many cases, can tolerate increased ripple voltage.

Key Applications

For battery charger applications, output capacitance and internal bleed resistors present themselves as a load to the connecting batteries. One common practice is to use a series diode to block reverse current flow with the sacrifice of increased cost and lower efficiency. The high slew rate option, with its lower output capacitance and lower loss bleed resistors, enables direct connection to batteries without series blocking diodes.

For photovoltaic emulation applications, higher bandwidth and lower output capacitance enable improved performance with higher speed, maximum power tracker algorithms. Maximum power tracker circuitry deviates the operating point of photovoltaic arrays to determine maximum power output. Slow responding emulation sources can present a problem when the speed of the algorithm exceeds that of the source. Furthermore, with lower output capacitance, changes in the operating point and transients, caused by shorting the solar inverter input, produce lower unwanted input currents.

The high-slew rate option enables the power supply to operate as a low frequency, power pulse generator. With the special capacitors selected for this option, it is possible to superimpose waveforms or produce a medium speed pulse on top of the dc output and expect normal capacitor life. It is important to note that the power supply output is single quadrant; that is, the output voltage or current cannot reverse.

Availability

The +HS option is available for the following product series:

- SL Series
- XR Series
- TS Series
- MS Series
- MT Series

XR Series models greater than 2000 Vdc already include a high slew rate output stage and no additional +HS option is available for these models.

Additional Specifications for High Slew Rate Output (+HS) Option

Max Voltage Rating	Output Capacitance SL Series (μF)	Output Capacitance XR Series (μF)	Output Capacitance TS Series MS Series (μF) ¹	Ripple (Vrms)
5	4235	13200	13200	0.5
8	N/A	N/A	9000	0.5
10	1740	4080	9000	0.5
16	1740	4080	4080	0.5
20	775	2340	2340	0.7
25	775	1170	2340	0.7
32	775	1170	1170	1.4
40	760	240	1170	1.5
50	760	240	1170	1.5
60	760	240	300	1.5
80	110	240	300	1.5
100	110	160	200	1.6
125	70	160	200	1.6
160	70	160	200	1.6
200	70	160	200	1.6
250	70	160	200	1.6
300	70	160	200	1.8
375	70	160	200	1.8
400	70	160	200	1.8
500	40	56	200	2.1
600	40	56	120	2.3
800	30	52	70	2.5
1000	30	52	60	3.0
1250	N/A	18	18	3.5
1500	N/A	18	18	3.5
2000	N/A	18	18	3.5
3000	N/A	N/A	9	4
4000	N/A	N/A	9	4
6000-10000	N/A	N/A	N/A	N/A

¹ For 20 to 30 kW models, multiply capacitance by 2
 For 45 kW models, multiply capacitance by 3
 For 60 kW models, multiply capacitance by 4
 For 75 kW models, multiply capacitance by 5
 For TS Series 4U/8U models and MT Series models, please contact Magna-Power support.

IEEE-488 GPIB (+GPIB)

The **IEEE-488 GPIB (+GPIB)** option, sometimes called the General Purpose Interface Bus (GPIB), is a general purpose digital interface system that can be used to transfer data between two or more devices. It is particularly well-suited for interconnecting computers and instruments. Some of its key features are:

- Up to 15 devices may be connected to one bus
- Total bus length may be up to 20 m and the distance between devices may be up to 2 m
- Communication is digital and messages are sent one byte (8 bits) at a time
- Message transactions are hardware handshaked
- Data rates may be up to 1 Mbyte/sec

The IEEE-488 GPIB interface is integrated with the power supply's rear communication ports. The IEEE 488 interface offers full compatibility with Magna-Power provided drivers, software and SCPI command set.

Availability

The +GPIB option is available for the following product series:

- SL Series
- XR Series
- TS Series
- MS Series
- MT Series

LXI TCP/IP Ethernet (+LXI) *LXI*

Certified to the LXI Standard (Class C), version 1.4, the **LXI TCP/IP Ethernet (+LXI)** allows the product to be fully controlled over an integrated TCP/IP Ethernet interface. LXI is an instrumentation platform based on industry standard Ethernet technology designed to provide modularity, flexibility, and performance to small- and medium-sized systems. All of the product's standard SCPI commands are supported over the +LXI option, along with all provided software and drivers.

LXI's advantages are exemplified in its compact, flexible package providing high-speed I/O and reliable measurements. The Magna-Power Electronics LXI TCP/IP Ethernet option includes an embedded web-server, allowing web browser power supply control and monitoring from virtually anywhere.

Availability

The +LXI option is available for the following product series:

- SL Series
- XR Series
- TS Series
- MS Series
- MT Series

Ruggedized (+RUG)

The **Ruggedized Option (+RUG)** provides additional mechanical security for large power components and sub-assemblies within SL Series and XR Series products.

SL Series and XR Series units with the Ruggedized Option have been independently tested to comply with the following MIL-STD-810G shock and vibration specifications:

- MIL-STD-810G CHG1 Method 516.7 Functional Shock, Procedure I; which subjects the product to 40G, 11 ms terminal saw tooth pulse; three shocks in each direction along three mutually perpendicular axes
- MIL-STD-810G CHG1 Method 514.7 Vibration; which subjects the product to two hours of vibration per axis along three mutually perpendicular axes

All products with the Ruggedized Option maintain ambient operating temperatures from 0°C to 50°C and ambient storage temperatures from -25°C to +85°C.

Availability

The +RUG option is available for the following product series:

- SL Series
- XR Series

Water Cooling (+WC)

The **Water Cooling (+WC)** option is available for Magna-Power power supplies for use in densely packaged system cabinets, where heat removal by the product's standard air cooling presents a challenge.

Water cooling is accomplished with chill plates and an integrated central heat exchanger. The chill plates provide a thermal conduction path for heat sensitive components and the central heat exchanger removes heat from air internal to the enclosure. An internal solenoid valve enables water flow when the chill plate reaches 60°C. Operation of the solenoid prevents internal condensation.

3U and 4U models have a 1/4" NPT male inlet and outlet for water flow. For 6U, 8U, and floor-standing models, external plumbing interconnects power supply modules to a single 1/2" NPT male connection: one for inlet, one for outlet. A minimum of 2.5" is recommended behind the enclosure for this hardware and user connections. For systems requiring more than one power supply, plumbing connections must be paralleled; that is, water should not flow from one power supply into another.

When water cooled power supplies are ordered in combination with the Cabinet and Integration accessory, Magna-Power will parallel the water inlet connections and parallel the water outlet connections, providing a single inlet and outlet for the rack.

Availability

The +WC option is available for models with maximum output voltage rating as specified for the following product series:

- TS Series, models rated from 1000 Vdc and below
- MS Series, models rated from 1000 Vdc and below

The +WC option cannot be combined with the +ISO option.

Specifications

Refer to the individual product series specifications.

Cabinet and Integration

Magna-Power's heavy-duty cabinet enclosures—fabricated by Magna-Power and available with or without product integration—are trusted by customers across many industries, including: military and defense, aerospace, industrial research and development, product testing, and education.

- **Cold-rolled USA 1008 steel**
Magna-Power's cabinet enclosures begin with 12-gauge cold-rolled USA 1008 steel that gets bent and welded within Magna-Power's metal processing operations. The resulting heavy-duty frame is then powder coated, with ground-plane surfaces carefully masked.
- **EIA-310 standard**
Vertical EIA-310 rails spanning the length of the cabinet in the front and rear are fabricated from 12-gauge galvanized steel.
- **Casters or pedestal base**
Standard 700-pound per caster rating with low resistance bearings allows heavy loads to be rolled with ease. An optional welded pedestal base increases the weight limit to over 4,000 lbs.

Specifications

Configuration	Integrated Units Cooling Method	Dimensions	Internal Rack Space
A1	Air	31.5" H x 24" W x 31.5" D (80.0 x 55.6 x 80.0 cm)	12U
B1	Water		
A2	Air	51" H x 24" W x 31.5" D (129.5 x 61.0 x 80.0 cm)	24U
B2	Water		
A3	Air	67" H x 24" W x 31.5" D (170.2 x 61.0 x 80.0 cm)	30U
B3	Water		
A4	Air	74" H x 24" W x 31.5" D (188.0 x 61.0 x 80.0 cm)	36U
B4	Water		
A5	Air	67" H x 48" W x 31.5" D (170.2 x 122.0 x 80.0 cm)	30Ux2 (60U Total)
B5	Water		
A6	Air	74" H x 48" W x 31.5" D (188.0 x 122.0 x 80.0 cm)	36Ux2 (72U Total)
B6	Water		
A7	Air	67" H x 72" W x 31.5" D (170.2 x 182.9 x 80.0 cm)	30Ux3 (90U Total)
B7	Water		
A8	Air	74" H x 72" W x 31.5" D (188.0 x 182.9 x 80.0 cm)	36Ux3 (108U Total)
B8	Water		



Qty (39) SL Series units in Qty (2) CAB2 (left) and Qty (1) CAB1 (right)

Cooling Solutions

Beyond the installation, Magna-Power also provides necessary cooling integrations for its cabinet enclosures, designed to integrate with Magna-Power programmable DC power supplies and electronic loads. Different cooling solutions are provided, as standard, depending on whether the integrated products are air or water cooled.

- **2,300 CFM+ air cooling**
For air cooled products integrated into the enclosure, high-quality top-mounted fans are installed to pull air from the enclosure's bottom opening and exhaust from the top. A provided control transformer with separate fusing allows fans to be powered from the same voltage as the integrated products. In addition, an integrated relay ensures the fans are not turned on unless the integrated product's control power is enabled.
- **Copper water cooling manifold**
For water cooled products integrated into the enclosure, a copper manifold is machined-to-order to provide a single inlet and outlet for the cabinet, with PEX tubing internally paralleling inlet and outlet cooling paths for the installed products.

Custom Integrations

Standard integration by Magna-power includes a full enclosed cabinet with casters and suitable cooling. Various additional accessories are available. Contact your Magna-Power sales partners for more information on custom integration.

Ordering Guide

There are many standard Magna-Power rack enclosure configurations available. The ordering guide below provides a guide for configuring standard rack enclosures. Custom rack enclosures will receive a special part number from Magna-Power's sales team.

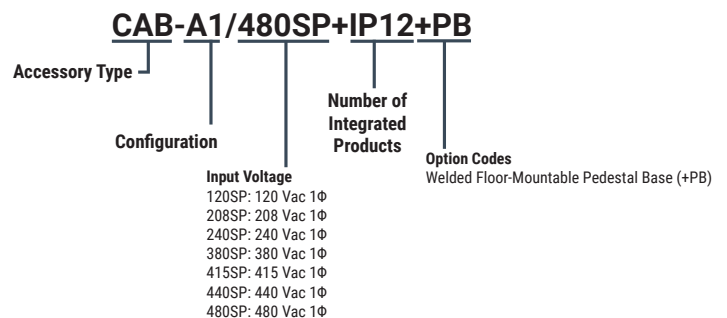

Qty (4) XR Series units in a CAB1

Accessories

DC Power Cables

Magna-Power offers a variety of DC power cables, built and tested in-house utilizing Magna-Power's internal cable manufacturing operations.

Ordering Guide

There are many DC cable configurations available, depending on the requirement. The ordering guide below provides a guide for configuring the appropriate cable configuration. Refer to the product diagrams for the respective product series for the DC output bus thread size and number of connection points.

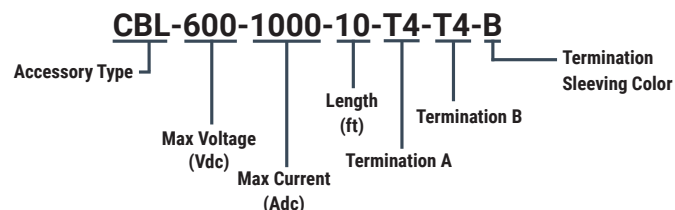

The following table provides availability of cable ratings and terminations:

Max Voltage	Max Current							Length	Termination						Termination Sleeving Color
	3.3 Adc	55 Adc	100 Adc	160 Adc	223 Adc	310 Adc	1000 Adc ¹		T0	T1	T2	T3	T4	T5	
600 Vdc	x	x	✓	✓	x	x	x	5, 10, 15, 20, 25, 30, 40, 50, 75, 100, 200, and 300 feet	✓	✓	✓	✓	x	x	B: Black G: Green O: Orange R: Red
2000 Vdc	x	x	x	x	✓	✓	x		✓	✓	✓	✓	x	x	
6000 Vdc	x	x	✓	✓	✓	✓	✓		✓	✓	✓	✓	x	x	
15,000 Vdc	x	✓	x	x	x	x	x		✓	✓	✓	✓	x	x	
20,000 Vdc	✓	x	x	x	x	x	x		x	✓	x	x	x	✓	

Maximum Current Ratings

Magna-Power's DC power cables are offered in 7 different current ratings, which correspond to the wire gauge. Multiple cables may be connected in parallel for increased current capability. Refer to the MagnaDC or MagnaLOAD product diagram for number of available connection points.

All current ratings are specified at 50 °C cable temperature with 25 °C ambient temperature in free air.

The following tables provides the wire gauges corresponding to the specified current ratings:

Max Current Rating	Wire Gauge
3.3 Adc	RG8-U Coaxial Cable
55 Adc	10 AWG (Flexible)
100 Adc	4 AWG (Flexible)
160 Adc	1 AWG (Flexible)
223 Adc	2/0 AWG (Flexible)
310 Adc	4/0 AWG (Flexible)
1000 Adc ¹	Custom Fabricated, 1.25" diameter (Flexible)

¹ 1000 Adc max current rated cable is compatible with T4 termination only

Terminations

Magna-Power offers various terminations for its cables in accordance with the cable ordering guide, above.

The following table defines the available terminations:

Termination	Description	Diagram Representation
T0	None	
T1	1" Stripped	
T2	1/4" Ring Terminal/Lug	
T3	3/8" Ring Terminal/Lug	
T4	Dual 3/8" Ring Terminal/Lug (Cembre CL750-D38)	
T5	Coaxial BNC	

Accessories

Universal Interface Device (UID47)

Magna-Power Electronics UID47 is a general purpose device for connection to Magna-Power Electronics' power supplies. The device contains the necessary circuitry for configuring power supplies for master/slave parallel or series operation.

Master/slave parallel operation allows two or more power supplies to equally share output current when connected together. Master/slave series operation allows two or more power supplies to equally share output voltage when connected together. In either operation mode, the master unit will command the slave units to the proper voltage and current. Each unit will display its own individual voltage and current. Installation requires setting jumpers, placing included 37-conductor cables between the UID47 and power supplies, and wiring the power supply outputs in either parallel or series.

The UID47 can be used as an interface for connecting control and monitoring lines to external circuitry. It also contains an area on the printed circuit board for interconnecting wires and placing components for specific user applications.

Key features of the UID47 option are as follows:

- Compatible with all Magna-Power Electronics power supplies
- Interface for series and parallel master/slave operation
- User configurable screw terminal connector
- Pad area for custom circuitry
- (2) 6-foot 37-pin cables included

Connectors	Master 1: DB-37, Female Master 2: DB-37, Female Slave: DB-37, Female User Interface Circuitry: 10-pin plug connector
Ambient Operating Temperature	0°C to 50°C
Storage Temperature	-25°C to +85°C
Size	1.24" H x 7.14" W x 4.01" D (3.15 x 18.14 x 10.19 cm)
Weight	0.5 lbs (0.23 kg)

For more detailed information about the UID47, refer to its User Manual.

RS485 (Converter)

The industrial RS232 to Addressable RS485 Converter allows non-addressable, "dumb" RS-232 devices to be connected on an addressable RS-485 network. The master node controls all communications to connected devices. By distributing the switching intelligence along the RS-485 network, wiring cost savings are substantial compared to a single switched "star" configuration.

Devices can either be polled by the master node or request access to the bus through a RS-232 handshake line. This provides a versatile system for interconnecting devices that are designed for point to point communications. Because the units communicate using standard RS-485 signals, RS-232 devices can form their own network or be added to an existing system. Up to 32 nodes at up to 4000 feet can be on one bus without a repeater, and the 485DSS's addressing scheme allows up to 256 units on a single network with repeaters.

USB (Converter)

The industrial RS232 to USB Converter offers instant I/O expansion for peripheral device connectivity. An out-of-the-box (external) alternative to PCI cards, Edgeport makes it easy to add serial port to a PC, server or thin client in minutes without opening the chassis, reconfiguring or rebooting the system.

The USB Converter device plugs directly into the back of the power supply, creating a seamless USB interface. Feature-rich design, reliability and unmatched operating system support make Edgeport USB-to-serial converters ideal for mission-critical enterprise applications. USB cable included along with associated drivers on the Magna-Power Electronics software CD.

Accessories

DBx Module



The DBx Module is a performance-enhancing series-connected add-on module for MagnaDC programmable DC power supplies, delivering ultra-high stability, low ripple, high precision and high accuracy, with voltage, current, and power control modes. The combination of the two products provides a broad range of magnet power supply solutions for high-energy physics and medical applications, including driving dipole, quadrupole, and steering magnets, as well as powering coils to establish stable magnetic fields. In addition, the high power density coupled with the high accuracy and low ripple characteristics make the combined solution ideal for ATE calibration applications.

Low Ripple Performance

The DBx Module Configuration A utilizes three stages of filters to suppress differential line-to-line EMI, common-mode line-to-ground EMI, and power supply ripple from the DC bus.

Internally fabricated common-mode and differential-mode EMI filters are integrated in the DBx Module Configuration A, providing insertion loss as high as 62 dB; typical results shown in the table below.

To filter power supply output ripple voltage, with components that can extend down to the mains power frequency, the DBx Module Configuration A utilizes a linear regulator, with a low DC voltage drop across a series-pass power semiconductor.

The regulator requires two feedback loops: one to maintain a 1.25 Vdc drop across the linear regulator and the second to produce a AC ripple canceling voltage across the series-pass power semiconductor, equal and opposite of the AC ripple voltage at the input. Adding a series connected diodes across the regulator provides protection for current surging and overvoltage transients—a weak point in conventional linear regulators.

Insertion Loss Measurements ¹						
Frequency (MHz)	0.05	0.15	0.50	1.0	10.0	30.0
Differential Mode (dB)	41.0	58.7	46.3	62.7	55.1	50.5
Common Mode (dB)	30.0	47.0	57.4	67.6	56.4	25.4

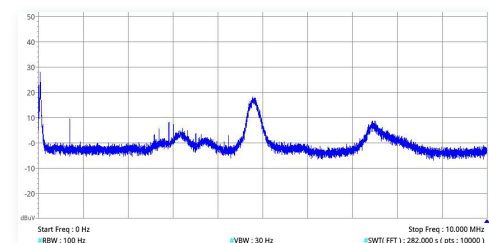

Differential mode noise on DC output without DBx Module

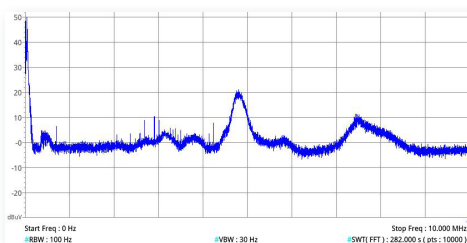

Common mode noise on DC output without DBx Module

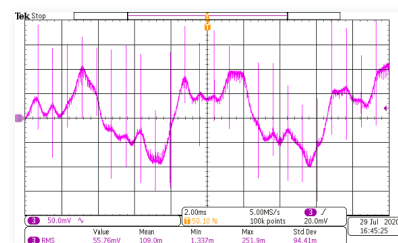

Voltage ripple on DC output without DBx Module

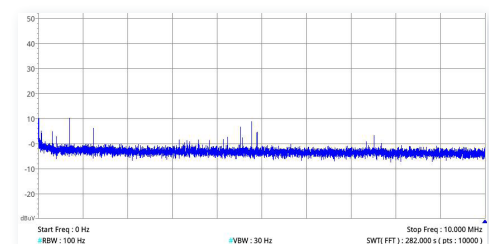

Differential mode noise on DC output with DBx Module¹

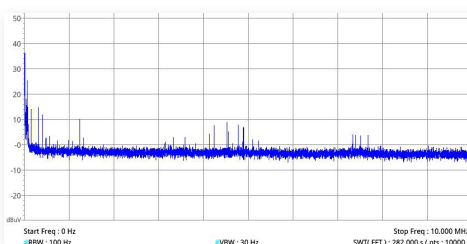

Common mode noise on DC output with DBx Module¹

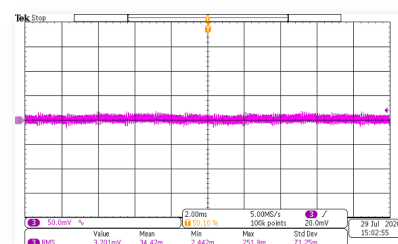

Voltage ripple on DC output with DBx Module¹

Key Facts

- Add-on module for MagnaDC power supplies
- Available from 1.5 kW to 3,000 kW+
- < 10 ppm stability
- Up to 24-bit resolution
- Up to 10x output ripple reduction
- Current ratings up to 6,000 Adc, Systems up to 24,000 Adc
- Voltage ratings up to 1,000 Vdc
- Voltage, current, and power control

Ultra-Stable, High Accuracy, and High Resolution

An ultra-stable fluxgate direct-current current transformer (DCCT) is used to take high accuracy isolated measurements from a series connection with the power supply's DC output. This ultra-stable transducer, combined with the DBx Module's low temperature drift resistors and temperature stabilized digital programming circuit, provides highly granulated programming (18-bit) and readback (24-bit), and enables long-term stability less than 5 ppm. Critical components are carefully laid out within a specially designed temperature compartment to accelerate the time to temperature stabilization.

Setup and Control

DBx Module Configurations A1 and B1 are provided with copper bus bars with threaded inserts for the DC input and DC output connections. In these configurations, the DC power supply output connects to the DBx Module's DC input and all current sensing is done internal to the DBx Module. The load / device under test gets connected to the DBx Module's DC output bus bars. DBx Module Configuration C1 uses an external DCCT with a control signal providing feedback to the DBx Module via its external user I/O connector. In all configurations, so that the DBx Module can control the power supply, a provided cable connects the DBx Module's interface connector to the power supply's JS1 37-pin external user I/O connector.

Digital programming of set points, trip points, and slew rates are performed using the DBx Module via front panel knob or keypad, front panel up-down arrows for highly granular single-bit control, or using the computer interface connections via provided MagnaWEB software or user defined software using SCPI commands. Included communication interfaces include RS485 and USB with optional TCP/IP Ethernet.



DBx Module rear view with DC input and DC output covers removed

DBx Module (Continued)

Configurations

The DBx Module is offered in three different configurations—A1, B1, and C1—differing in maximum current capability and internal stages.

The DBx Module **Configuration A1** contains all stages, including the linear regulator, differential- and common-mode DC EMI filters, temperature-stabilized ultra-high stability controller, and DCCT. Configuration A occupies a 1U (1.75" high) rack-mount enclosure and is available for voltages from 10 Vdc to 1,000 Vdc and three different max current ratings, at 75 Adc, 150 Adc, and 225 Adc.

The DBx Module **Configuration B1** is intended for applications that do not require additional DC filtering and contains only the temperature-stabilized ultra-high stability controller and DCCT. Configuration B occupies a 1U rack-mount enclosure and is available for voltages from 10 Vdc to 1,000 Vdc and three different max current ratings, at 75 Adc, 150 Adc, and 225 Adc.

The DBx Module **Configuration C1** is intended for high-current applications, where the 1U rack-mount enclosure contains only the temperature-stabilized ultra-high stability controller, with a provided external DCCT that ties into the DBx Module through a rear connector. Configuration C is available for voltages from 10 Vdc to 1,000 Vdc and max current ratings from 300 Adc to 6,000 Adc.

Available Configurations

Config	EMI/ Ripple Filter	High Stability, Precision, Accuracy	Max Voltage Rating Available	Max Current Rating Available	Form Factor
A1	✓	✓	10 Vdc to 1,000 Vdc	75 Adc, 150 Adc, or 225 Adc	1U Enclosure
B1	✗	✓	10 Vdc to 1,000 Vdc	75 Adc, 150 Adc, or 225 Adc	1U Enclosure
C1	✗	✓	10 Vdc to 1,000 Vdc	500, 750, 1500, 3000, 5000, or 10000 Adc	1U Enclosure + External Transducer

Model Ordering Guide DBx Module models are defined by the configuration type and number (see "Available Configurations" table), the maximum voltage rating, and the maximum current rating. Any voltage from Magna-Power's standard MagnaDC power supply offering is available, from 10 Vdc to 1,000 Vdc. The DBx Module resolution step size and calibration is a function of its maximum ratings, therefore it's recommend to specify a model most closely matched to the requirement.



DBx Module right side view (top) and left side view (bottom)

Specifications

Performance Specifications

Stability Voltage Control	< 10 ppm
Stability Current Control	< 10 ppm
Temperature Coefficient Voltage Control	< 0.05 ppm/°C
Temperature Coefficient Current Control	< 0.5 ppm/°C
Programming Resolution	18-bit
Measurement Resolution	24-bit
Programming Accuracy	± 0.04%; voltage control ± 0.04%; current control
Rise/Fall Time Maximum	Voltage Mode: 1 s, 10% to 90% max voltage Current Mode: 1 s, 10% to 90% max current Power Mode: 1 s, 10% to 90% max power
Power Loss Configuration A1 Only	Current output x 1.5 volts
Warm-up Time	45 min

Connection Specifications

AC Input 1Φ, 2-wire + ground	IEC 60320 connector
DC Input	Bus bars with 3/8" threaded insert; 250 Adc max
DC Output	Bus bars with 3/8" threaded insert; 250 Adc max
Communication Interfaces (Standard)	USB Host (Front): Type B USB Host (Rear): Type B RS485 (Rear): RJ-45 External User I/O: 25-pin D-Sub, female
Communication Interfaces (Optional)	LXI TCP/IP Ethernet (Rear): RJ-45

Physical Specifications

Size and Weight Configuration A1 Configuration B1	1U 1.75" H x 19" W x 24" D (4.4 x 48.3 x 61.0 cm) 35 lbs (15.88 kg)
Size and Weight Configuration C1	1U (See Above) + External Transducer External transducer size and weight will vary depending on current rating

Environmental Specifications

Ambient Operating Temperature	0°C to 50°C
Storage Temperature	-25°C to +85°C
Humidity	Relative humidity 30% to 90%, non-condensing
Air Flow	Side intake, rear exhaust

Regulatory Compliance

EMC	Complies with 2014/30/EU (EMC Directive) CISPR 22 / EN 55022 Class A
Safety	Complies with EN61010-1 Complies with 2014/35/EU (Low Voltage Directive)
CE Mark	Yes

RoHS Compliant measured at full load. Specifications are subject to change without notice.

BDx Module



High-power rack-mount blocking diode solution

For applications or products where the Integrated Blocking Diode (+BD) option is not available or desired, the BDx Module offers a turn-key rack-mount blocking diode solution, including:

- Fully integrated and enclosed heatsinking and fan cooling
- User I/O status feedback including a temperature alarm state
- Front panel status indicator
- Heavy-duty tin-plated copper bus bars
- Remote sensing terminal for voltage feedback compensation
- Universal single phase active-PFC AC input connection

Internally, semiconductors are secured to Magna-Power manufactured heatsinks with fans and integrated thermocouples. An internal microprocessor monitors the internal temperature and provides +5V digital output signal when the system is powered and in a normal operating state. This +5V signal can be easily integrated into interlock systems, to ensure power is only driven through the BDx Module when its powered on and cooling is functional. Additional, a +5V digital input allows control of when the BDx Module is turned off and on, providing complete integration with a connected power supply.

Specifications

AC Input Specifications

AC Input 1Φ, 2-wire + ground	85 to 265 Vac
AC Input Connector	IEC 60320 C13 receptacle
AC Input Frequency	50-60 Hz
AC Input Isolation	±1500 Vac, maximum input voltage to ground

Physical Specifications

Racking Standard	EIA-310
Rear Support Rails	Included
Size and Weight Configuration A1	1U 1.75" H x 19" W x 24" D (4.4 x 48.3 x 61.0 cm) 35 lbs (15.88 kg)

Environmental Specifications

Ambient Operating Temperature	0°C to 50°C
Storage Temperature	-25°C to +85°C
Humidity	Relative humidity 30% to 90%, non-condensing
Air Flow	Side intake, rear exhaust

Regulatory Compliance

EMC	Complies with 2014/30/EU (EMC Directive) CISPR 22 / EN 55022 Class A
Safety	Complies with EN61010-1 Complies with 2014/35/EU (Low Voltage Directive)
CE Mark	Yes
RoHS Compliant	Yes

Key Facts

- Add-on module for MagnaDC power supplies
- 4 models addressing broad range of applications
- Protection up to 1,200 Vdc
- Forward current up to 1,200 Adc
- Fully integrated cooling with status indicator
- Power supply user I/O controls interface
- Included fixed rail rack-mount kit



Back EMF Protection

Prevent back-electromotive force (EMF) from electric motors or from the connection of charged batteries and capacitors from flowing back into the output of your power supply.



High Voltage Protection

Protect your power supply and other DC power equipment from externally generated DC bus voltages that could exceed the equipment's maximum ratings.



Mixed Voltage Paralleling

Connect multiple power supplies with different voltage ratings in parallel and protect lower voltage products high bus voltages.



Prevent Load Discharge

Prevent the power supply's internal bleeder network from discharging batteries, capacitors or fuel cells when the power supply is standby, faulted state, or turned off.

Model Ordering Guide

BDx Module models are defined by the configuration type and number, the maximum DC input voltage rating, and the maximum current rating.

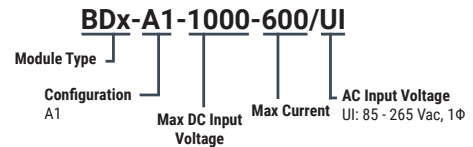

Model	Config	Max DC Input Voltage	Max Current	Reverse Voltage Raing	Typical Losses
BDx-A1-1000-300/UI	A1	1000 Vdc	300 Adc	1200 Vdc	Up to 1.4%
BDx-A1-150-600/UI	A1	150 Vdc	600 Adc	200 Vdc	Up to 2.5%
BDx-A1-1000-600/UI	A1	1000 Vdc	600 Adc	1200 Vdc	Up to 1.4%
BDx-A1-150-1200/UI	A1	150 Vdc	1200 Adc	200 Vdc	Up to 2.5%

External User I/O Specifications

External User I/O Port	15-pin D-sub DB-25, female See User Manual for pin layout
Digital Output Voltage System Status	+5V when systems normal. 0V when off or faulted state. Connected to MagnaDC interlock input via provided cable.
Digital Input Voltage Enable	+5V to engage cooling fans. 0V to disable product. Connected to MagnaDC power status output via provided cable.
Remote Sense	6-32 screw connection for positive terminal

Photovoltaic Power Profile Emulation Software

Intuitive Solar Emulation Software • 1.5 kW to 3000 kW+

Introduction

The Photovoltaic Power Profile Emulation (PPPE) software automatically calculates solar array voltage and current profiles based on user-defined parameters. These profiles can be sequentially sent to a Magna-Power Electronics power supply, which will emulate defined characteristics. The user can define a limitless number of profiles to be emulated and sequenced over a given time period.

Design and production validation for photovoltaic connected electronics requires a photovoltaic emulating power source with flexible output characteristics. Inverters and specialized DC-DC converters employ maximum power point tracking (MPPT) control algorithms to maximize utilization of nonlinear energy sources, such as solar panels and wind turbines. For development and manufacturing, using photovoltaic arrays for validation is costly with uncontrolled source characteristics. By utilizing a power supply with user-programmable output characteristics, the user can evaluate the full range of power conditions.

After the profile is defined, it can be transferred to the power supply for either static or dynamic emulation. A time dependent parameter defines how long the power supply should emulate that profile before loading the next profile in the sequence.

Modeling and Operation

A profile is a voltage/current curve that the power supply's output should emulate. There are three methods to generate a power profile in the PPPE software:

Automatic, based on solar array parameters

The user selects the desired solar panel technology, nominal temperature, irradiance, voltage and current values. Each V-I profile is then defined only by new temperature and irradiance values. The rest of the parameters: maximum power point (V_{mp} , I_{mp}), open circuit voltage (V_{oc}), and short circuit current (I_{sc}); are all calculated automatically in accordance with the EN50530 standard.

Automatic, based on 4-parameters

The user defines the maximum power point (V_{mp} , I_{mp}), open circuit voltage (V_{oc}), and short circuit current (I_{sc}). The profile is then generated based on these parameters.

Manual

The user defines up to 50 current and voltage points for the power supply to emulate. The power supply performs a piecewise linear approximation between points to provide a smooth output curve.

Key Features

- Automatic voltage current profile calculation from reference parameters
- Autosequencing through power profiles, at user-defined rate
- Graphical profile view and real-time output with advanced graphical viewer panel
- Compatible with all Magna-Power MagnaDC programmable DC power supplies with modulation capability
- EN50530 V-I curve generation model
- Curve interpolation for smooth transitions
- SCPI command export for solar emulation functionality in LabVIEW
- Data logging
- Curve import and export

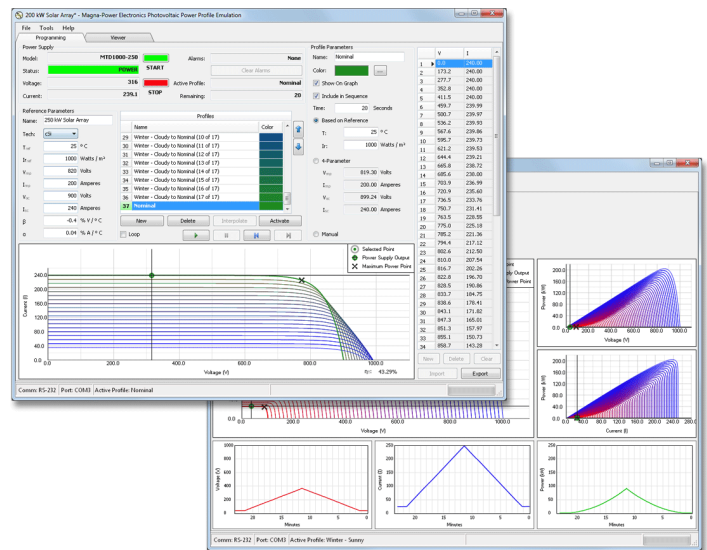

Magna-Power Electronics Photovoltaic Power Profile Emulation (PPPE) software: main programming window (foreground); Viewer window (background)

Advanced Features

Magna-Power Electronics worked closely with solar inverter manufacturers to refine the PPPE feature-set. Some of the key advanced PPPE features are as follows:

EN50530 Modeling

The European EN50530 standard provides a new algorithm for proper solar array modeling. PPPE 2.0 incorporates this model, furthermore allowing the selection of thin film or polycrystalline silicon parameters. Defining a curve is as simple as specifying desired open-circuit voltage, short-circuit current, and maximum power point. Alternatively, manual parameters can be entered for more customized modeling or profile importing from an external file.

Live Output Viewer

A new live output viewer provides six graphs of instantaneous output parameters versus time. This data allows the user to visualize fluctuations in voltage, current, and power over time.

Curve Interpolation

An interpolation function was added to automatically generate transitional curves. This functionality enables smooth transitions from one curve to another over a user-defined period of time.

Data Logging

Customizable data logging functionality was added, allowing for report generation and data analysis using external tools. Data is exported to a comma-delimited (.csv) file.

Command Export

Leverage the ease of profile generation in PPPE and export the generated SCPI commands for integration into a separate programming environment, such as LabVIEW/LabWindows.

The following figure provides the voltage error as a function of operating bandwidth during solar array emulation:

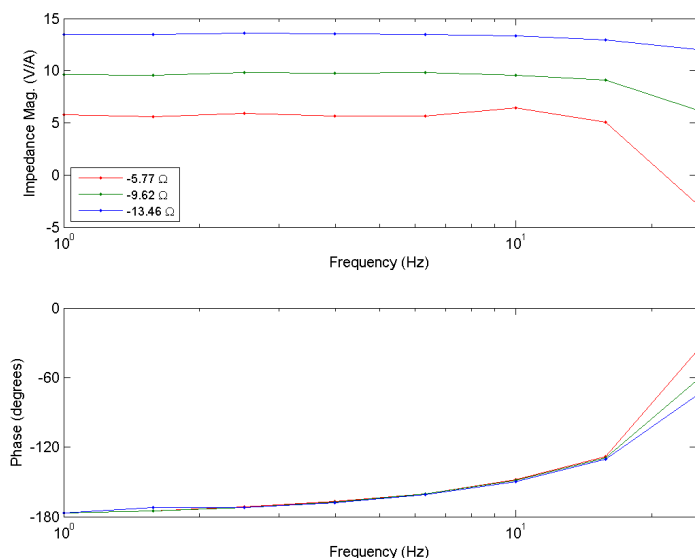

PPPE Operating Specifications

Bandwidth	With High Slew Rate Output (+HS) Option: 15 Hz Standard Models: 2 Hz
Communication Interfaces Supported	RS232, LXI TCP/IP Ethernet, IEEE 488 GPIB, USB
Minimum Time Between Sequential Profiles	2
Number of Profile Sequences	Unlimited
Minimum Voc and Isc	10% of the power supply's rated voltage and current
Maximum Profile Slope	$(\Delta I / \Delta V) \times (I_{max} / V_{max}) \leq -0.05$
Instantaneous Load Change to Short-circuit	Supported with High Slew Rate Output (+HS) option



1.5 MW solar array emulator using Magna-Power MT Series power supplies at the National Renewable Energy Laboratory in Golden, Colorado USA

Overview of Current-Fed Power Processing

Switching power supplies in the tens of kilowatt power range have been slowly replacing traditional silicon controlled rectifier (SCR) based topologies over the past several decades. The advantages and disadvantages are well known. High frequency operation of switching power supplies enables magnetic components to be reduced in size and weight and allows faster response times to line and load perturbations. The principle disadvantage is that the demands placed on switching devices tend to make high power switching power supplies less reliable than their SCR based counterpart.

Numerous power circuit topologies are currently being deployed for high-power switchmode applications. The most common configurations consist of three power conversion stages:

- An AC to DC converter which converts the 3-phase incoming mains to a DC voltage.
- A DC to AC inverter or converter which converts the voltage on the DC bus to a high-frequency AC voltage.
- A secondary AC to DC converter which converts the high-frequency AC voltage to DC voltage.

The two AC to DC converters are very similar in function except for the operating frequencies; the converters consist primarily of rectifiers, low pass filters, and snubbers. The snubbers limit switching transient voltages and absorb energy stored from parasitic components. The second stage, the DC to AC converter, generates a high-frequency voltage which drives a transformer at a frequency generally at 20 kHz or above. The transformer is required for ohmic isolation and production of an output voltage as determined by the transformer turns ratio. The DC to AC converter is the most complex stage and there are numerous power processing topologies presently in production.

Most high-power DC to AC converters utilize a H-bridge configuration, four power devices, for exciting the high-frequency transformer. The H-bridge is controlled with pulse width modulated (PWM) or with other modulation strategies to produce a voltage of limited pulse width or amplitude. Modulation of the H-bridge produces a controllable output voltage.

DC to AC converter topologies fall into three groups: hard-switched converters, soft-switched converters, and resonant converters. The primary difference between the topologies is the switching device's load line during the commutation period (switching transition). It is during the commutation period where power devices dissipate the most power.

Hard-switched converters allow the power devices and/or snubbers to absorb commutation energy. Soft-switched converters have additional passive circuitry to shape power waveforms to reduce losses during the commutation period. The advantage of reduced commutation losses is offset with increased circuitry complexity, additional on-state losses (due to waveform modification), and sensitivity to loading conditions. Resonant power converters have highly tuned tank circuits which cause either device voltage or current to appear sinusoidal. The advantages and disadvantages are similar to soft-switched converters. Resonant power converters are second-order and timing is more critical than soft-switched converters.

Hard-switched, soft-switched, and resonant converters are usually designed to operate from a DC voltage source and are commonly referred to as voltage-fed converters. Characteristically, voltage-fed converters are prone to shoot through problems which can occur when one device fails to turn off before the other series connected device turns on. While protective circuitry can be designed to minimize catastrophic problems, generally, such protective circuitry must be effective to detect shoot through problems in one to two microseconds. Variation of device parameters and abnormal modulation of voltage-fed converters can cause half-cycle voltage imbalance which can result in transformer core saturation. Protective circuitry must also have a response to detect these conditions before damage can occur in the power semiconductors.

Current-fed power converters [1]-[3], the electrical dual of voltage-fed converters, is still another, but less known and used,

power circuit alternative for power conversion. The advantage of these power converters over their voltage-fed counterpart is that shoot through and half cycle symmetry cannot cause device failure or core saturation. This is characteristic of SCR based converters and one of the main reasons why current-fed converters tend to be more robust. The main disadvantage of current-fed converters is that a fourth power conversion stage is required to convert the DC bus voltage to a DC current. While the added stage results in additional complexity and losses, the power conversion stages can be made to work more efficiently. Current-fed power converter topologies are implemented less than voltage-fed converters primarily because of cost.

This article describes the differences between voltage-fed and current-fed converters and the sensitivities to conditions causing power semiconductor stress. Issues for implementing the fourth power conversion stage, the voltage to current converter, are also discussed.

Characteristics of Voltage-Fed Converters

A simplified schematic of a voltage-fed converter is illustrated in Figure 1. The converter consists of a H-bridge, insulated gate bipolar transistors (IGBT) Q1 through Q4, power transformer T1, and output rectifier diodes D5 through D8. The input voltage source can be a battery, DC power supply, or rectified AC bus. For practical reasons, capacitor C1 is required to ensure a low impedance bus at higher frequencies. Inductor L1 and capacitor C2 form a low pass filter that removes the AC components on the output.

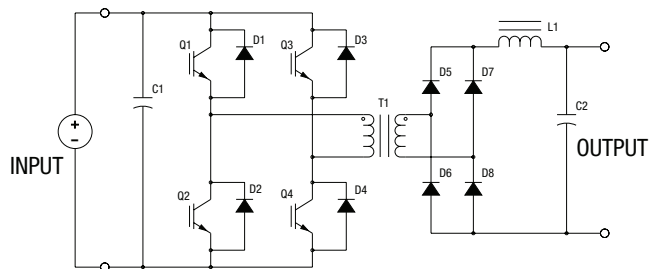

Figure 1. Voltage-Fed Converter

With conventional, hard-switched, PWM modulation schemes, Q1, Q4 conduct for a fraction of a half-cycle and Q2, Q3 conduct for a fraction of the other half-cycle. This excites transformer T1 equally on alternate half-cycles. Averaging the rectified voltage on the secondary side of the transformer produces a DC output voltage that is proportional to the conduction period of the IGBT's.

Timing on voltage-fed converters is critical. If IGBT's Q1, Q2 or Q3, Q4 conduct simultaneously, current rapidly rises in the conducting devices leading to device failure in microseconds. To prevent this critical operating condition, designers introduce turn-on delays in the modulation schemes, monitor DC bus currents, and sense on-state conditions of the power devices. The challenge of successfully implementing these protective schemes is that circuitry must be both responsive to high speed faults and insensitive to electrical noise. This is a formidable challenge especially when power levels are on the order of tens of kilowatts.

A secondary issue with voltage-fed converters is the production of DC voltages with variations of on-state voltages, variations with rise and fall times, and erroneous switching states. Exciting a transformer with DC voltage causes core saturation and power device failure as previously described. Typical methods to circumvent catastrophic events are the placement of air gaps in the transformer, placement of DC blocking capacitors in series with the transformer primary winding, and deploying current mode modulation for cycle by cycle current balancing.

Characteristics of Current-Fed Converters

Current-fed converters are the electrical dual of voltage-fed converters. As illustrated in Figure 2, current-fed converters consist of a H-bridge, IGBT's Q1 through Q4, power transformer T1, and

output rectifier diodes D5 through D8. The input current source has to be created with additional power electronic circuitry. For practical reasons, inductor L1 is required to ensure a high impedance bus at higher frequencies. Unlike a voltage-fed converter, the output filter consists of a single component, capacitor C1.

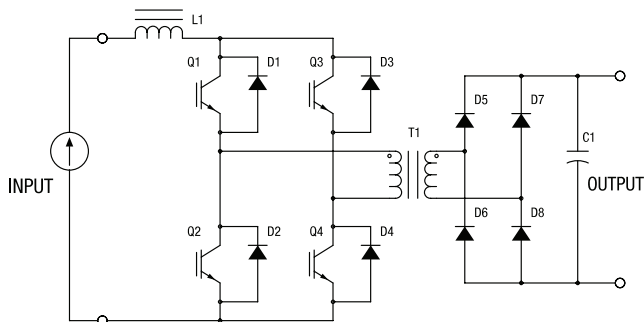

Figure 2. Current-Fed Converter

Current-fed converters operate in a mode where voltage and current waveforms are transposed from that of voltage-fed converters. Operation requires IGBT's Q1 through Q4 to be PWM modulated, but in this case, with the constraint that Q1, Q3 or Q2, Q4 are never allowed to be simultaneously placed in a non-conducting state. The constraint ensures the input impedance of the H-bridge is always finite; otherwise, a current source feeding into an open current would produce a destructive high voltage. (As should be noted, constraints placed on switching states and conditions of abnormal operation are the electrical dual of the voltage-fed topology.) Averaging the rectified current on the secondary side of the transformer produces a DC output current that is proportional to the conduction period of the IGBT's.

Transformer T1, being excited with a current PWM waveform, is basically insensitive to variations of on-state voltages, variations with rise and fall times, and erroneous switching states. With current-fed converters, core saturation can be prevented as long as the ampere-turn excitation is within the bounds of normal operation even if the current is DC.

The disadvantage of current-fed converters is the fact that current sources are not commonly available and such sources must be created from a voltage source. Deployment of buck converters or choppers is an obvious choice because of their very efficient use of power semiconductors. With this extra power conversion stage, control can be placed in the current-fed converter, chopper, or both. Figure 3 shows a high-power converter with a 3-phase input rectifier, chopper, current-fed converter, and output rectifier.

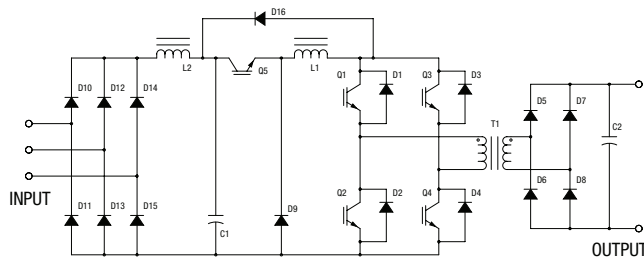

Figure 3. Rectifier, chopper, and current-fed converter

The novel feature of the current-fed converter combined with an input chopper is its performance under abnormal operating conditions. Transformer T1, IGBT's Q1 through Q5, and diodes D1 through D8 can all operate in a shorted state with system level protection. Under such conditions, the rate of rise of current is a function of the applied voltage across inductor L1 divided by its inductance. Inductor L1 is typically sized to maintain a peak to peak ripple current within a fraction of its maximum value. As long as system shutdown occurs within the switching period of the chopper, peak currents are well controlled. Permitting an extended fault detection period allows fault protection circuitry to be well

filtered enabling robust, nuisance free tripping operation in high electrical noise environments.

Another key feature of the chopper and current-fed converter combination is that each circuit can protect each other from abnormally high currents with a single detecting scheme. A fault in the converter stage can be protected with the chopper shutdown and a fault in the chopper stage can be protected with the current-fed converter shutdown.

The previous constraints placed on the switching states of the current-fed converter can be circumvented with the introduction of catch diode D16. This component provides a current return path for IGBT's Q1, Q3 or Q2, Q4 when the devices are turned off. Diode D16 clamps the maximum off state voltage of the H-bridge to the voltage across capacitor C1.

Conclusion

This article describes the general characteristics of high power voltage-fed and current-fed converters and their sensitivity to device parameter variations and erroneous switching states. Voltage-fed converters generally have series connected power devices across an input capacitor. Abnormal switching states can permit simultaneous device conduction causing currents to increase very rapidly. In addition, voltage-fed converters can also produce DC offsets which can cause the magnetic core of the main transformer to saturate. To protect power semiconductors under these conditions, high speed fault detection is required. The protection of power semiconductors in high, electrical noise environments is difficult.

Current-fed converters are the electrical dual of voltage-fed converters and prefer a shorted state to an open state of operation. These topologies cannot create fast rising current spikes and cannot cause magnetic core saturation under erroneous conditions. Current-fed converters operate with the robustness of SCR based power supplies, but at high-frequency. Current-fed converters require an additional power processing stage which can be used for control and enhanced system protection.

References

- [1] A. I. Pressman, *Switching Power Supply Design - Second Edition*, New York, NY: McGraw-Hill, 1998.
- [2] P. Wood, *Switching Power Converters*, New York, NY: Van Nostrand Reinhold Company, 1981.
- [3] D. W. Shimer, A. C. Lange, J. N. Bombay, "A High-Power Switch-Mode DC Power Supply for Dynamic Loads," presented at the IEEE-IAS Annual Meeting, Oct. 1994.





Where to Buy

Magna-Power Electronics Partners and Sales Offices

North America

Headquarters, Manufacturing

Magna-Power Electronics, Inc.
39 Royal Road
Flemington, NJ 08822
United States of America

Phone: 1-908-237-2200
Email: sales@magna-power.com
magna-power.com

United Kingdom

Sales Office

Magna-Power Electronics Limited
400 Thames Valley Park Drive
Reading, Berkshire RG6 1PT
United Kingdom

Phone: +44 1189 663143
Email: sales.uk@magna-power.com
magna-power.com

China

Sales Office

Magna-Power Electronics Co., Ltd.
6F, 56 East 4th Ring Road Middle
Beijing, 100025
China

Phone: +86 139 1068 4490
Email: sales.zh@magna-power.com
magna-power.com/zh

Distributors of Magna-Power Electronics products are located worldwide.

To find the nearest sales partner, please visit:
magna-power.com/contact

Magna-Power Electronics – designing and delivering rugged programmable power products, built in the USA to the highest quality standards through a vertically integrated manufacturing process.

Published by
Magna-Power Electronics, Inc.
Flemington, NJ 08822 USA

© 2022 Magna-Power Electronics, Inc.
All Rights Reserved.

Visit us:
magna-power.com

ATTENTION

The information and specifications given in this document are subject to change without notice.

INFORMATION

For further information on technology, terms and conditions, and product prices, contact the nearest Magna-Power Electronics sales partner (magna-power.com/contact).

Cal Power

Via Acquenera, 29 22100 COMO
tel. 031.526.566 (r.a.) fax 031.507.984
info@calpower.it www.calpower.it